Operating instructions

Industrial Piston Air Compressors Motor Driven Package

HD30GY12E-335

Pump Model: LP335

Engine: 12 HP

Air Tank: HD30

7502 Mesa Road Houston, TX77028

Telephone: (713) 635-6331

E-mail: service@lapante.com

Web Site: www.laplantecompressor.com



Issue: 08/2010

No.

	Page
Contents	
Introduction	1
Unpacking and handling	2
Appropriate use	4
Symbols used	5
Symbols used	5
Symbols on the package	6
Safety guide	8
Technical Data	17
Specification	17
Explode drawing	18
Bom list	19
 Section I	
 Pump	
Installation instruction	1
Technical data	1
Outline drawing	2
Explode drawing	3
Bill of material list	4
Operation	14
Parts kits	1
Overhaul Kit	1
Ring Set	1
Valve Set	1
Gasket Set	1
Disassemble pump	2
Assemble pump	2
Troubleshooting	4
Maintenance	7
General	7
Safety information	7
Check oil level	8

Check and clean compressor valves	8
Check the safety valve	10
Change oil	11
Check and change air filter	14
Maintenance intervals	15
List of Maintenance and service work	16

Section II

Engine

Safety information	2
Pre-Operation check	5
Fuel	5
Engine oil	6
Starting the engine	7
Stopping the engine	9
Periodic maintenance	10
Spark plug	11
Engine oil replacement.....	12
Air filter	13
Fuel filter	13
Muffler screen	14
Sparker arrester	15
Fuse replacement	16
Storage	17
Troubleshooting	18

Section III

Combination Valve

General	1
Pilot valve	1
Identifying the problem	1
Adjustment procedure tools	4
Check valve	6
Safety information	6

Section IV

Air Tank

General	1
Safety information	1
Check the safety valve	2
Condensate	2

Section V

V-Belt

General	1
Safety information	1
Maintenance intervals	1
List of Maintenance and service work	16

Introduction

These operating instructions form part of the machine and must be made available to the compressor operating personnel at all times. In order to receive maximum performance and long life from your compressor, the following instructions should carefully read and all points regarding installation and operation of the unit should be noted and observed. Careful reading of this manual, prior to connecting anything to the motor or compressor, will pay dividends in long term trouble-free operation.



Unpacking and Handling



Occasionally damage will occur during shipping. Be sure to carefully inspect the unit before unpacking and after unpacking **BEFORE** you sign the receiver. If any has occurred, document it with the trucking firm immediately. Contact your LAPLANTE representative for assistance.

To move your compressor to its installation site we recommend that you leave the unit on its shipping skid as long as possible. The forks should be extended the width of the compressor and padding should be placed between the compressor and the fork truck boom.

If it is necessary to lift the compressor with a crane, we recommend the use of spreader bar and chains. The spreader bar should be greater than the width of the compressor and padding placed on the edges to prevent chain damage.



DO NOT UTILIZE THE PUMP OR DRIVE AS A LIFT POINT

Procedure for Handling Damaged Shipments

1. The customer, at the receiving point, **MUST** inspect each shipment for damage.
2. If the shipment is damaged, the customer should so note it on the freight bill.
3. The customer should request an inspector from the freight company to inspect the equipment immediately. It is best to send a confirming letter with the following information:
 - a. Freight bill number.
 - b. Date delivered - shipper's name & address.
 - c. Description of item(s) damaged.
 - d. Description of damage (a Polaroid picture if possible).
 - e. A copy of your invoice for the equipment.
4. After inspection, (before the inspector leaves):
 - a. Get a copy of the inspection report.
 - b. Request the unit be shipped back "free astray".
 - c. Request a credit for the original freight bill.
5. Call the factory and:
 - a. Get a Return Material Authorization (RMA number).
 - b. Give a purchase order for repair. The purchase order should refer to the item and trucker claim.



6. We will accept the shipment back, repair (under normal conditions) and return it within (7) seven working days.
7. We will invoice the customer for the repair, which will then become part of your claim. The Invoice must be presented to the trucking claim department along with their claim form.
8. We suggest if the trucker does not pay within 30 days that you call and / or write the ICC making a formal complaint of poor service. Also advise **LAPLANTE** in writing for follow-up.
If damage can be repaired at the receiving point, follow Procedure 1, steps 1 through 4a. Repair the unit and make out a detailed invoice to the trucker showing labor hours, labor rate, materials used, and cost of materials.

Storage

In some cases it may necessary to store the compressor for extended periods of several months before placing the unit in operation. When this is required do the following:

Cover and seal all machine openings to prevent the entrance of water and dirt.

Cover all openings in open drip proof motors to prevent the entrance of rodents.

If the storage conditions are below freezing, drain off the tank, traps, and attendant piping.

We do not recommend outside storage.

Cover with a waterproof tarpaulin that can easily be removed for in storage maintenance.

While in storage, every two to three months rotate the compressor and motor by hand to prevent flat spots on the bearings that will lead to premature failure.

At the end of the storage period, follow the uncrating and start-up procedures. If the unit has been stored for more than eighteen months you should contact **LAPLANTE** before restarting the compressor.



Appropriate use

As standard, **LAPLANTE** piston compressors are intended for the compression of ambient air. The air may not contain any aggressive or combustible mixtures.

The pressure chambers of the compressor are oil-lubricated. Therefore, the compressed air produced may only be used as breathing air or come into contact with food if it has been treated beforehand.



As standard this LAPLANTE piston compressor is not of an explosion-protected design and it may not be operated in areas subject to explosion hazards!



Symbols used

We have used the following symbols in this text to mark particularly important points:



The general warning sign indicates information concerning possible danger to operator and machine.

The lightning symbol indicates work which must exclusively be performed by skilled electricians.

The pointing hand indicates particularly important statements.

The spanner indicates maintenance work.



Danger is used to indicate the presence of a hazard, which will cause severe personal injury, death or substantial equipment and property damage if the warning is ignored.



Warning is used to indicate the presence of a hazard that can cause severe personal injury, death or substantial equipment and property damage if the warning is ignored.



Caution is used to indicate the presence of a hazard that will or can cause personal injury or equipment and property damage if the warning is ignored.



Notice is used to notify people of installation, operation, or maintenance of information that is important but not hazard related.

Symbols on the compressor

**Warning:**

Hot surfaces: Do not touch!

**Warning:**

The unit is operated by remote control, and might start without warning.

**Note:**

Instructions for the operating personnel must be read.

**Prohibited:**

Never open the valve before the air hose (connection to the compressed air network) is connected.

**Forbidden**

TO remove protective covering and safety devices

**Danger:**

Hot or noxious gases outlet: unbreathable

**Danger:**

High voltage disconnect power source before servicing



Danger:
Spray injury!

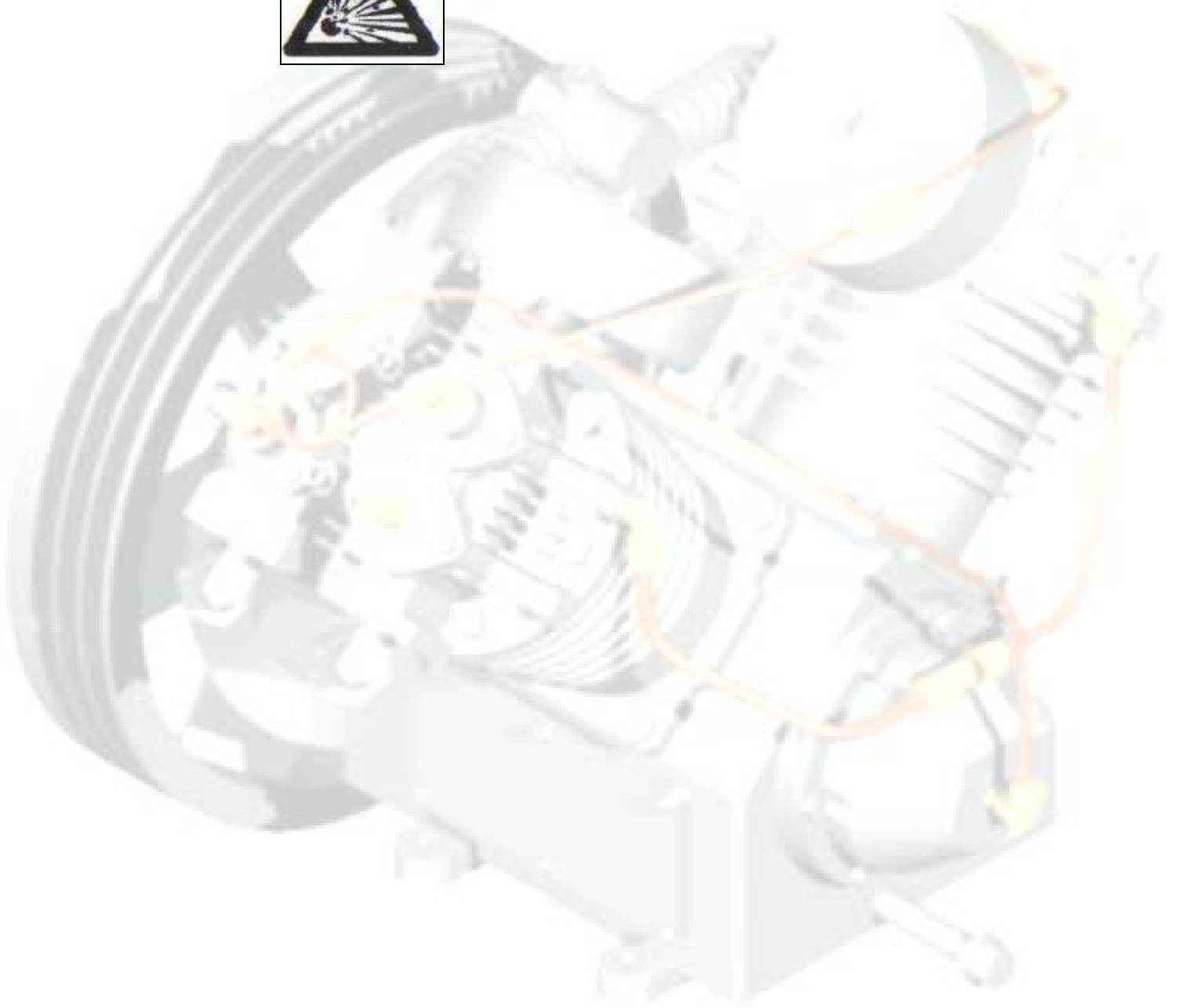

Safety Guide

Compressor Safety Precautions



An air compressor is a dynamic piece of machinery needing the same common sense safety precautions that should be observed with any operating machinery. Careless operation or maintenance is hazardous to personnel.



In addition to the obvious safety rules that should be followed with machinery, we recommend the following additional safety precautions.

1. Read and understand all instructions completely before operating this compressor.
2. Disengage power mains and disconnect power lines to the machine, if used, prior to attempting to work or perform maintenance on this unit.
3. Open tank discharge valve and relieve all pressure from tank and compressor lines. Do not attempt to remove any pressurized system parts without first relieving the pressure within the unit.
4. Do not attempt to service any part while the machine is in operation.
5. Do not operate the compressor at pressures in excess of its indicated rating on the compressor nameplate.
6. Do not operate the compressor at speeds in excess of its indicated rating on the compressor nameplate.
7. Do not remove guards, shields, or screens while the compressor is operating. If removed for maintenance replace before resuming operation.
8. Observe the delivery pressure gauge daily to be sure the automatic control system is operating within proper limits.
9. Periodically check all safety and relief devices for proper operation.
10. Do not play with compressed air. Pressurized air can cause serious injury or death to personnel.
11. Be sure that no tools, rags, or loose parts are left on the compressor or drive parts.

12. Do not use flammable solvents for cleaning parts.
13. Exercise cleanliness during maintenance and when making repairs.
Keep dirt away from parts and exposed openings by covering with a clean cloth or Kraft paper.
14. Install pressure relief valves in any isolatable piping in the plant system.
15. Do not operate the compressor in areas where there is the possibility of ingesting flammable or toxic gases.
16. Check pipe for any signs of wear or deterioration before each use and make certain that all connections are secure.
17. Observe the prescribed maintenance intervals.
18. Only use genuine **LAPLANTE** parts.
19. Only use **LAPLANTE** compressor oils and operating material recommended by **LAPLANTE**.
20. Strictly observe the effluent disposal laws of your local authority when disposing of condensate!



Make sure to investigate the code requirements to ensure compliance prior to operating the compressor.



The owner, lessor, or operator of this compressor is hereby notified and forewarned that any failure to observe these safety precautions may result in injury, death and/or property damage.



TRADE SECRET –CONFIDENTIAL AND PROPRIETARY
 EXCLUSIVELY OWNED BY LAPLANTE COMPRESSOR, LTD.,
 ANY COPYING, USE OR DISCLOSURE WITHOUT THE WRITTEN
 PERMISSION OF LAPLANTE COMPRESSOR, LTD. IS STRICTLY
 PROHIBITED. THIS MATERIAL IS PROTECTED UNDER
 TRADE SECRET AND UNFAIR COMPETITION LAWS. THE
 EXPRESSION OF THE INFORMATION IS PROTECTED UNDER
 FEDERAL COPYRIGHT LAWS. VIOLATIONS MAY RESULT IN
 CIVIL AND CRIMINAL FINES AND PENALTIES.

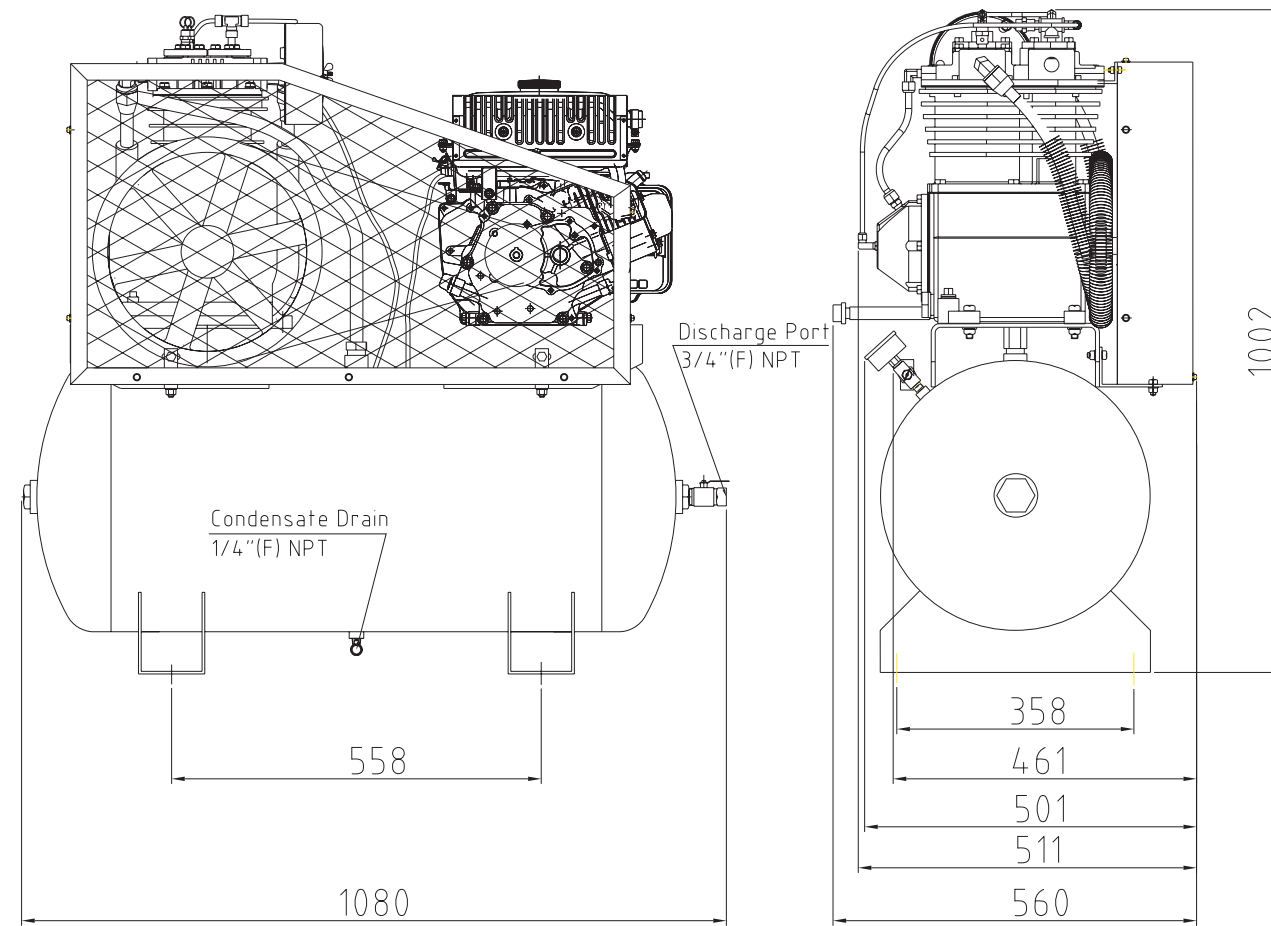

Specification:

Pump:

- Type: LP335
- Cylinders: 2
- Bore of LP : 4.75"/121mm
- Bore of HP : 2.5"/63.5mm
- Stroke: 3"/76mm
- RPM: 908
- Pump Flywheel: 13.75"/349.25mm/2B

Engine:

- Power: 12HP/8.95Kw
- Electric Control
- RPM: 3600
- Engine Pulley:

Tank:

- 30Gal/113.6Ltr
- Max. Pressure: 200Psi

Combination Valve:

- Combination Valve Control

Rating CFM @ 125Psi: 21.95
 @ 155Psi: 21.71
 @ 175Psi: 22.24

Rating ACFM @ 125Psi: 21.29
 @ 155Psi: 21.06
 @ 175Psi: 20.57

Standard Package:

- Single : 1 Pcs, Weight: XXXLB/XXXKg
- Crate : xxx Pcs, Weight: xxxLB/xxxxKg
- 20' Container : xxx Pcs
- 40' Container : xxx Pcs



Address: 7502 Mesa Road Houston, TX 77028
 Telephone: (713) 635-6291
 E-mail: sales@Lapante.com
 Web Site: www.Laplantecompressor.com

TITLE

HD30GY12E-335 Specification

Explode drawing

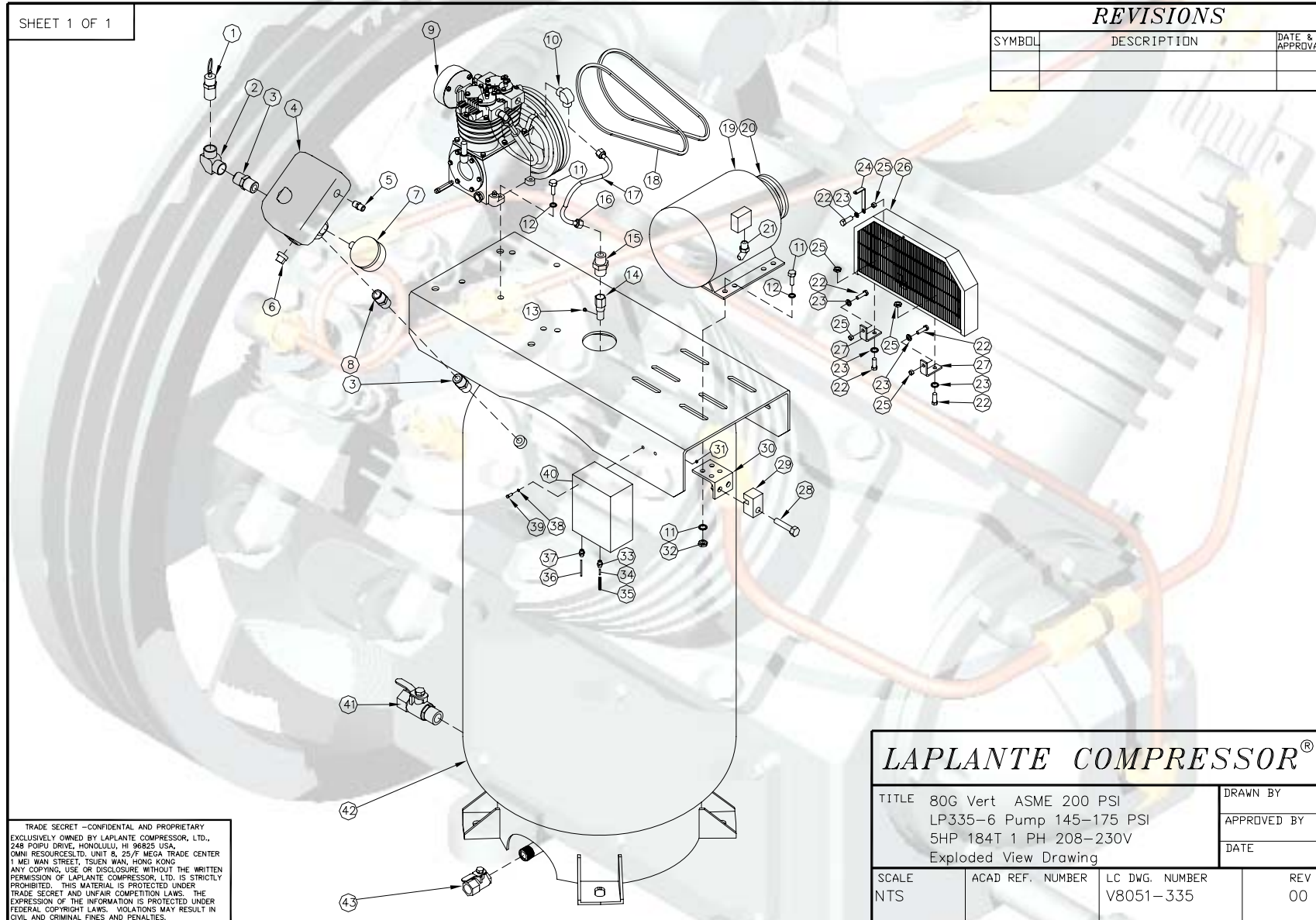

V8051-335 Bill of material list

V8051-335 Parts List			
Item	LAP#	Description	QTY
1	690008	Valve, Safety; ASME 200PSI 1/4M	1
2	640021	Elbow, 90Deg, 1/4M 1/4F	1
3	640058	Fitting 1/4 F, 1/4M	2
4	340007	Pressure Switch; 140-175 PSI	1
5	290042	Quick Connector M22x1.5	1
6	140100	Plug, Hex; 1/4M	1
7	350015	Gauge, Air; 300 PSI 2" 1/4M Left w/ oil	1
8	640000	Nipple; Brass; 1/4M 1/4M	1
9	800098	Pump; LP335-6	1
10	640025	Elbow 45Deg 3/4M 1-1/16"-12UN M	1
11	110261	Bolt HexHead,M10X50	12
12	130104	Washer, Flat; 10mm Large	8
13	140103	Plug, Hex; 1/8M	1
14	690024	Check Valve, Brass; 3/4M 3/4F 1/8F	1
15	640034	Nipple, 3/4M 1-1/16"-12UN M	1
16	120114	Nut, Compression; 1-16UNF	2
17	320021	Tube cooper ø19 0. D.	1
18	420002	V-Belt A 1600Li 63"	2
19	240023	Motor, 5HP 184T 1PH 208-230V TEFC 4P	1
20	713235	Pulley; 2BK60H-1 1/8" w/Bushing	1
21	290056	Elbow Connector M22X1.5	1
22	110281	Bolt, Hexhead; M8x25	5
23	130103	Washer, Flat; 8mm Large	5
24	524004	Bracket, Belt Guard Top	1
25	120108	Nut, Nyloc; M8	5
26	520028	Belt Guard Assy	1
27	523028	Bracket, Belt guard Bottom	2
28	110260	Bolt, Hexhead; M10X80	1
29	390000	Tension Block	1
30	390001	Tension Plate	1
31	120115	Nut, Nyloc; M5	2
32	120109	Nut, Nyloc; M10	8
33	290038	Cable Clamp M22X1.5	1
34	290014	Wire Set Starter	1
35	290053	Wire Connector	1
36	290013	Wire Set Pressure Switch	1
37	290037	Cable Clamp M20X1.5	1
38	130116	Washer, Flat; 5mm	4
39	110285	Screw Hex Socket Head M5X20	2
40	340018	Starter Ass. Magnetic	1
41	690014	Ball Valve, Brass; 3/4M 3/4F	1
42	330023	Tank, 80G VERT ASME 200 PSI	1
43	690009	Ball Valve, Brass; 1/4F 1/4F	1

Operating instructions

Industrial piston air compressors

Model: LP335

7502 Mesa Road Houston, TX77028

Telephone: (713) 635-6331

E-mail: service@lapante.com

Web Site: www.lapantecompressor.com



Issue: 06/2010

Contents	Page
SECTION I	1
INTRODUCTION	1
UNPACKING AND HANDLING	2
APPROPRIATE USE	4
SYMBOLS USED	5
SYMBOLS USED	5
SYMBOLS ON THE COMPRESSOR	6
SAFETY GUIDE	8
SECTION II	1
INSTALLATION INSTRUCTION	1
TECHNICAL DATA	1
EXPLODE DRAWING.....	2
BILL OF MATERIAL LIST.....	3
INSPECTION	5
HEAD UNLOADER	7
CENTRIFUGAL UNLOADER.....	11
OPERATION	14
SECTION III	1
PARTS KITS.....	1
OVERHAUL KIT	1
RING SET.....	1
VALVE SET	1
GASKET SET	1
BOLT TORQUE CHART	2
DISASSEMBLE PUMP.....	3
ASSEMBLE PUMP.....	5
TROUBLESHOOTING	7
MAINTENANCE	7
GENERAL.....	7
SAFETY INFORMATION	8
CHECK OIL LEVEL	8
CHECK AND CLEAN COMPRESSOR VALVES.....	10
CHECK THE SAFETY VALVE	11
CHANGE OIL	14
CHECK AND CHANGE AIR FILTER.....	14
MAINTENANCE SCHEDULE	15
LIST OF MAINTENANCE AND SERVICE WORK	16

Introduction

These operating instructions form part of the machine and must be made available to the compressor operating personnel at all times. In order to receive maximum performance and long life from your compressor, the following instructions should carefully read and all points regarding installation and operation of the unit should be noted and observed. Careful reading of this manual, prior to connecting anything to the motor or compressor, will pay dividends in long term trouble-free operation.



Unpacking and Handling



Occasionally damage will occur during shipping. Be sure to carefully inspect the unit before unpacking and after unpacking **BEFORE** you sign the receiver. If any has occurred, document it with the trucking firm immediately. Contact your LAPLANTE representative for assistance.

To move your compressor to its installation site we recommend that you leave the unit on its shipping skid as long as possible. The forks should be extended the width of the compressor and padding should be placed between the compressor and the fork truck boom.

If it is necessary to lift the compressor with a crane, we recommend the use of spreader bar and chains. The spreader bar should be greater than the width of the compressor and padding placed on the edges to prevent chain damage.



DO NOT UTILIZE THE PUMP OR DRIVE AS A LIFT POINT

Procedure for Handling Damaged Shipments

1. The customer, at the receiving point, **MUST** inspect each shipment for damage.
2. If the shipment is damaged, the customer should so note it on the freight bill.
3. The customer should request an inspector from the freight company to inspect the equipment immediately. It is best to send a confirming letter with the following information:
 - a. Freight bill number.
 - b. Date delivered - shipper's name & address.
 - c. Description of item(s) damaged.
 - d. Description of damage (a Polaroid picture if possible).
 - e. A copy of your invoice for the equipment.
4. After inspection, (before the inspector leaves):
 - a. Get a copy of the inspection report.
 - b. Request the unit be shipped back "free astray".
 - c. Request a credit for the original freight bill.
5. Call the factory and:
 - a. Get a Return Material Authorization (RMA number).
 - b. Give a purchase order for repair. The purchase order should refer to the item and trucker claim.



6. We will accept the shipment back, repair (under normal conditions) and return it within (7) seven working days.
7. We will invoice the customer for the repair, which will then become part of your claim. The Invoice must be presented to the trucking claim department along with their claim form.
8. We suggest if the trucker does not pay within 30 days that you call and / or write the ICC making a formal complaint of poor service. Also advise **LAPLANTE** in writing for follow-up.
If damage can be repaired at the receiving point, follow Procedure 1, steps 1 through 4a. Repair the unit and make out a detailed invoice to the trucker showing labor hours, labor rate, materials used, and cost of materials.

Storage

In some cases it may necessary to store the compressor for extended periods of several months before placing the unit in operation. When this is required do the following:

Cover and seal all machine openings to prevent the entrance of water and dirt.

Cover all openings in open drip proof motors to prevent the entrance of rodents.

If the storage conditions are below freezing, drain off the tank, traps, and attendant piping.

We do not recommend outside storage.

Cover with a waterproof tarpaulin that can easily be removed for in storage maintenance.

While in storage, every two to three months rotate the compressor and motor by hand to prevent flat spots on the bearings that will lead to premature failure.

At the end of the storage period, follow the uncrating and start-up procedures. If the unit has been stored for more than eighteen months you should contact **LAPLANTE** before restarting the compressor.



Appropriate use

As standard, **LAPLANTE** piston compressors are intended for the compression of ambient air. The air may not contain any aggressive or combustible mixtures.

The pressure chambers of the compressor are oil-lubricated. Therefore, the compressed air produced may only be used as breathing air or come into contact with food if it has been treated beforehand.



As standard this LAPLANTE piston compressor is not of an explosion-protected design and it may not be operated in areas subject to explosion hazards!



Symbols used

We have used the following symbols in this text to mark particularly important points:



The general warning sign indicates information concerning possible danger to operator and machine.

The lightning symbol indicates work which must exclusively be performed by skilled electricians.

The pointing hand indicates particularly important statements.

The spanner indicates maintenance work.



Danger is used to indicate the presence of a hazard, which will cause severe personal injury, death or substantial equipment and property damage if the warning is ignored.



Warning is used to indicate the presence of a hazard that can cause severe personal injury, death or substantial equipment and property damage if the warning is ignored.



Caution is used to indicate the presence of a hazard that will or can cause personal injury or equipment and property damage if the warning is ignored.



Notice is used to notify people of installation, operation, or maintenance of information that is important but not hazard related.

Symbols on the compressor

**Warning:**

Hot surfaces: Do not touch!

**Warning:**

The unit is operated by remote control, and might start without warning.

**Note:**

Instructions for the operating personnel must be read.

**Prohibited:**

Never open the valve before the air hose (connection to the compressed air network) is connected.

**Forbidden**

TO remove protective covering and safety devices

**Danger:**

Hot or noxious gases outlet: unbreathable

**Danger:**

High voltage disconnect power source before servicing



**Danger:
Spray injury!**

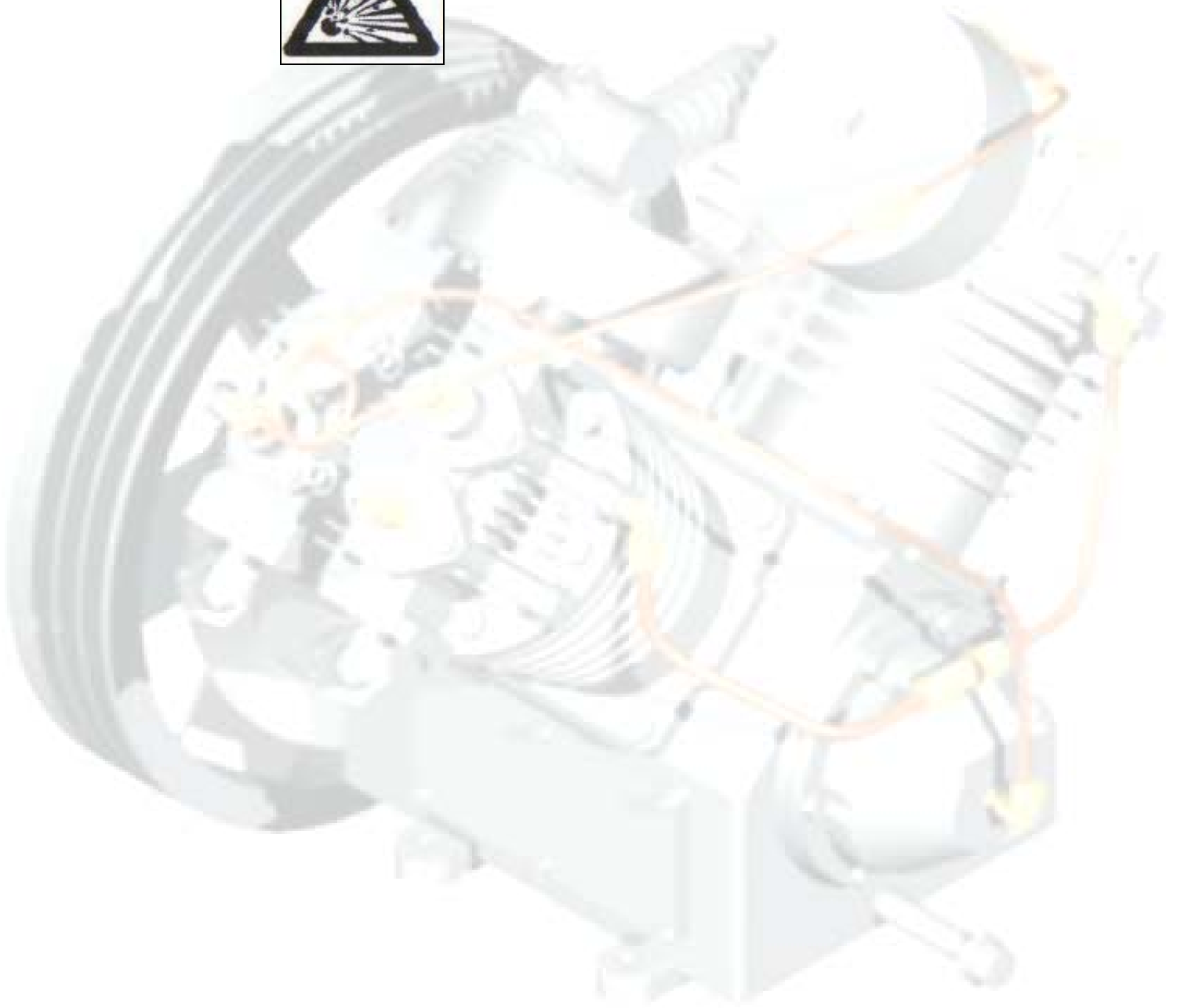

Safety Guide

Compressor Safety Precautions



An air compressor is a dynamic piece of machinery needing the same common sense safety precautions that should be observed with any operating machinery. Careless operation or maintenance is hazardous to personnel.



In addition to the obvious safety rules that should be followed with machinery, we recommend the following additional safety precautions.

1. Read and understand all instructions completely before operating this compressor.
2. Disengage power mains and disconnect power lines to the machine, if used, prior to attempting to work or perform maintenance on this unit.
3. Open tank discharge valve and relieve all pressure from tank and compressor lines. Do not attempt to remove any pressurized system parts without first relieving the pressure within the unit.
4. Do not attempt to service any part while the machine is in operation.
5. Do not operate the compressor at pressures in excess of its indicated rating on the compressor nameplate.
6. Do not operate the compressor at speeds in excess of its indicated rating on the compressor nameplate.
7. Do not remove guards, shields, or screens while the compressor is operating. If removed for maintenance replace before resuming operation.
8. Observe the delivery pressure gauge daily to be sure the automatic control system is operating within proper limits.
9. Periodically check all safety and relief devices for proper operation.
10. Do not play with compressed air. Pressurized air can cause serious injury or death to personnel.
11. Be sure that no tools, rags, or loose parts are left on the compressor or drive parts.

12. Do not use flammable solvents for cleaning parts.
13. Exercise cleanliness during maintenance and when making repairs.
Keep dirt away from parts and exposed openings by covering with a clean cloth or Kraft paper.
14. Install pressure relief valves in any isolatable piping in the plant system.
15. Do not operate the compressor in areas where there is the possibility of ingesting flammable or toxic gases.
16. Check pipe for any signs of wear or deterioration before each use and make certain that all connections are secure.
17. Observe the prescribed maintenance intervals.
18. Only use genuine **LAPLANTE** parts.
19. Only use **LAPLANTE** compressor oils and operating material recommended by **LAPLANTE**.
20. Strictly observe the effluent disposal laws of your local authority when disposing of condensate!



Make sure to investigate the code requirements to ensure compliance prior to operating the compressor.



The owner, lessor, or operator of this compressor is hereby notified and forewarned that any failure to observe these safety precautions may result in injury, death and/or property damage.



TRADE SECRET –CONFIDENTIAL AND PROPRIETARY
 EXCLUSIVELY OWNED BY LAPLANTE COMPRESSOR, LTD.,
 ANY COPYING, USE OR DISCLOSURE WITHOUT THE WRITTEN
 PERMISSION OF LAPLANTE COMPRESSOR, LTD. IS STRICTLY
 PROHIBITED. THIS MATERIAL IS PROTECTED UNDER
 TRADE SECRET AND UNFAIR COMPETITION LAWS. THE
 EXPRESSION OF THE INFORMATION IS PROTECTED UNDER
 FEDERAL COPYRIGHT LAWS. VIOLATIONS MAY RESULT IN
 CIVIL AND CRIMINAL FINES AND PENALTIES.

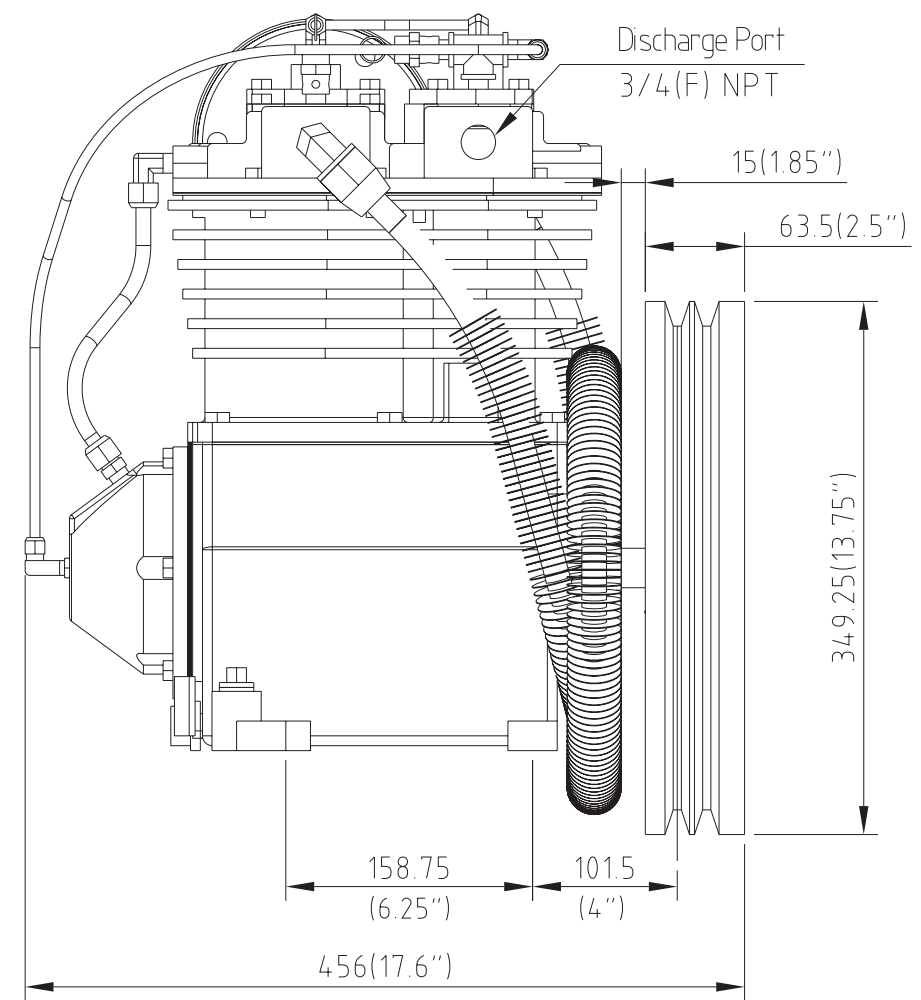
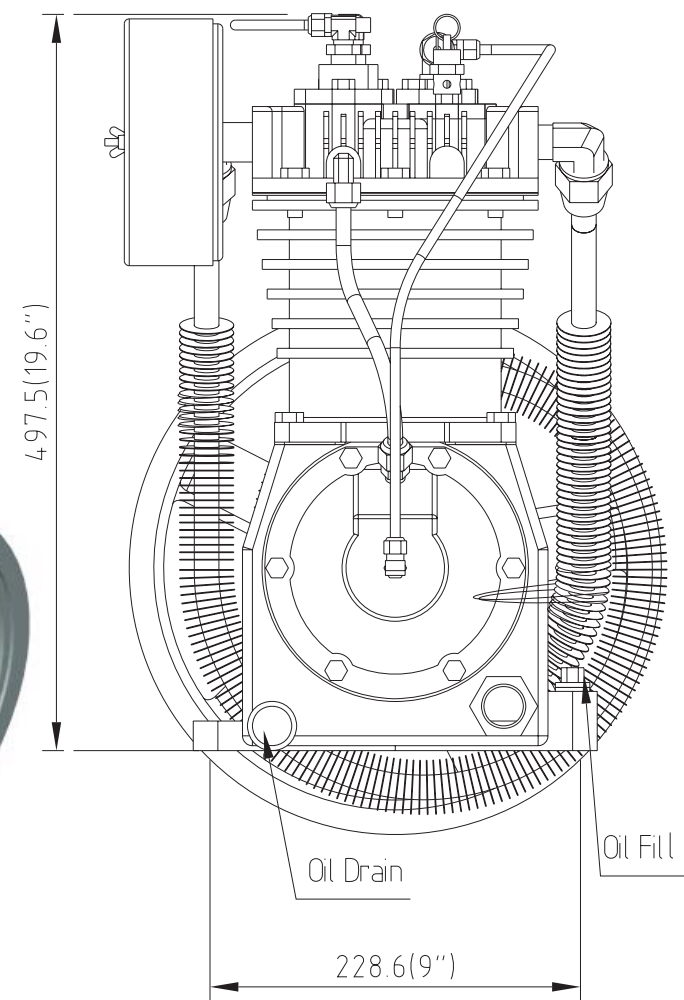

Specification:

- Power Range: 3~8HP/2.2~6Kw
- Maximum Pressure: 175Psi/12Bar
- Cylinders: 2
- Bore of LP: 4.75"/121mm
- Bore of HP: 2.5"/63.5mm
- Stroke: 3"/76mm
- RPM: 400~1000
- Flywheel Dia./Groove: 13.75"/349.25mm/2B

Features:

- Cast Iron Crankcase
- Cast Iron Cylinder
- Cast Iron Cylinder Head
- Ductile Iron Crankshaft
- Ductile Iron Conn. Rod
- Head Unloader and Centrifugal Unloader
- Cage Needle Bearings Wrist Pin
- Babbitt Bearings Crankshaft
- Taper Main Bearings
- Steel Breather and Brass Sight Glass
- Power Coated Steel Filter Silencer
- Filled with DAB150 Lubricant
- Synthetic Lubricant as Optional

Standard Package:

- Single : 1 Pcs,Weight:145LB/66Kg
- Crate : 10 Pcs,Weight:1538LB/700Kg
- 20' Container : 210 Pcs
- 40' Container : 330 Pcs

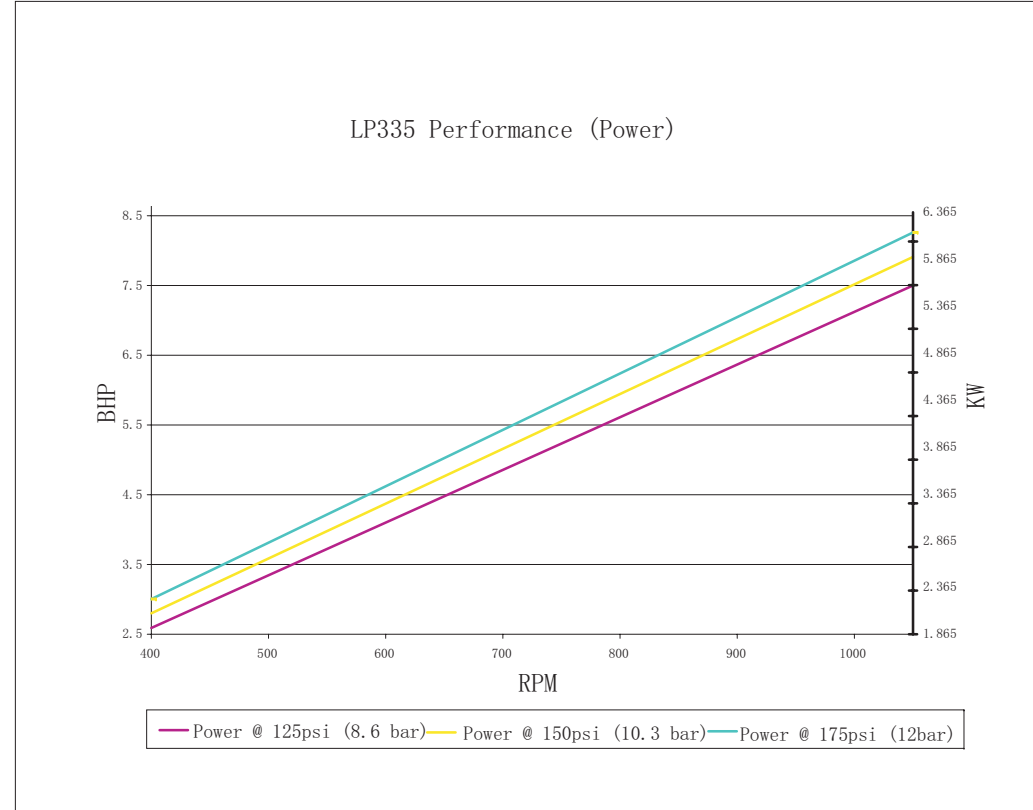
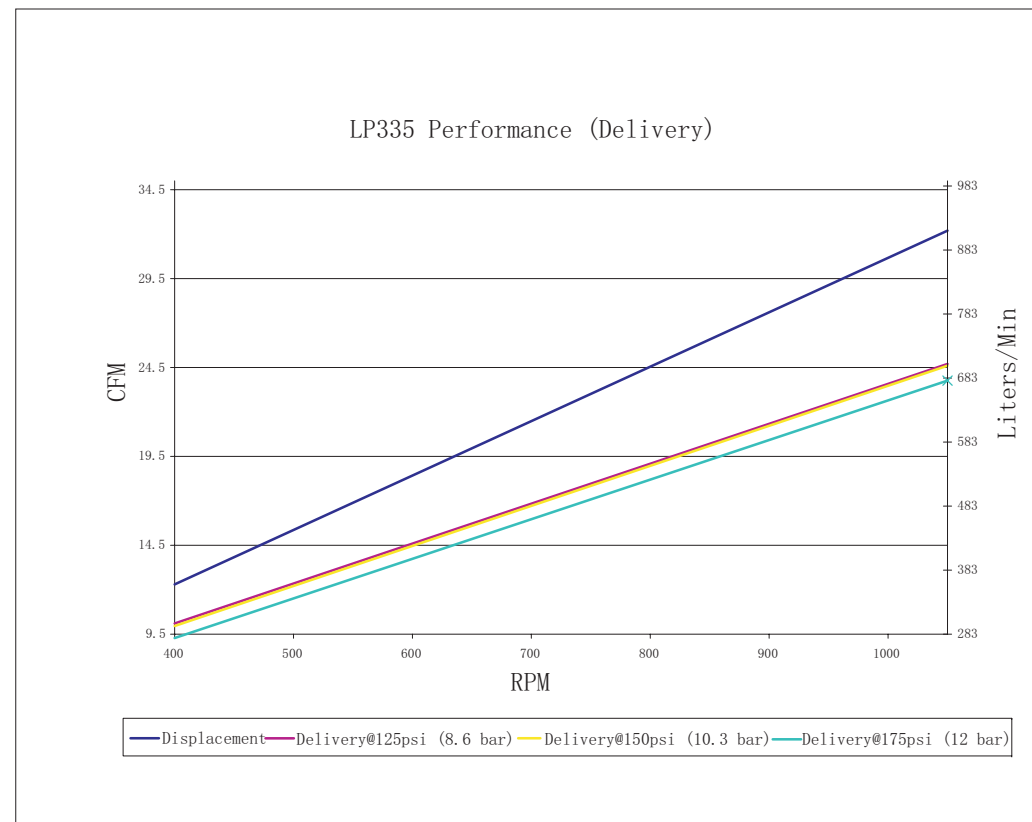

Address:7502 Mesa Road Houston, TX77028
 Telephone: (713) 635-6291
 E-mail: sales@Lapante.com
 Web Site: www.Laplantecompressor.com

TITLE
LP335 Specifications

Explode drawing

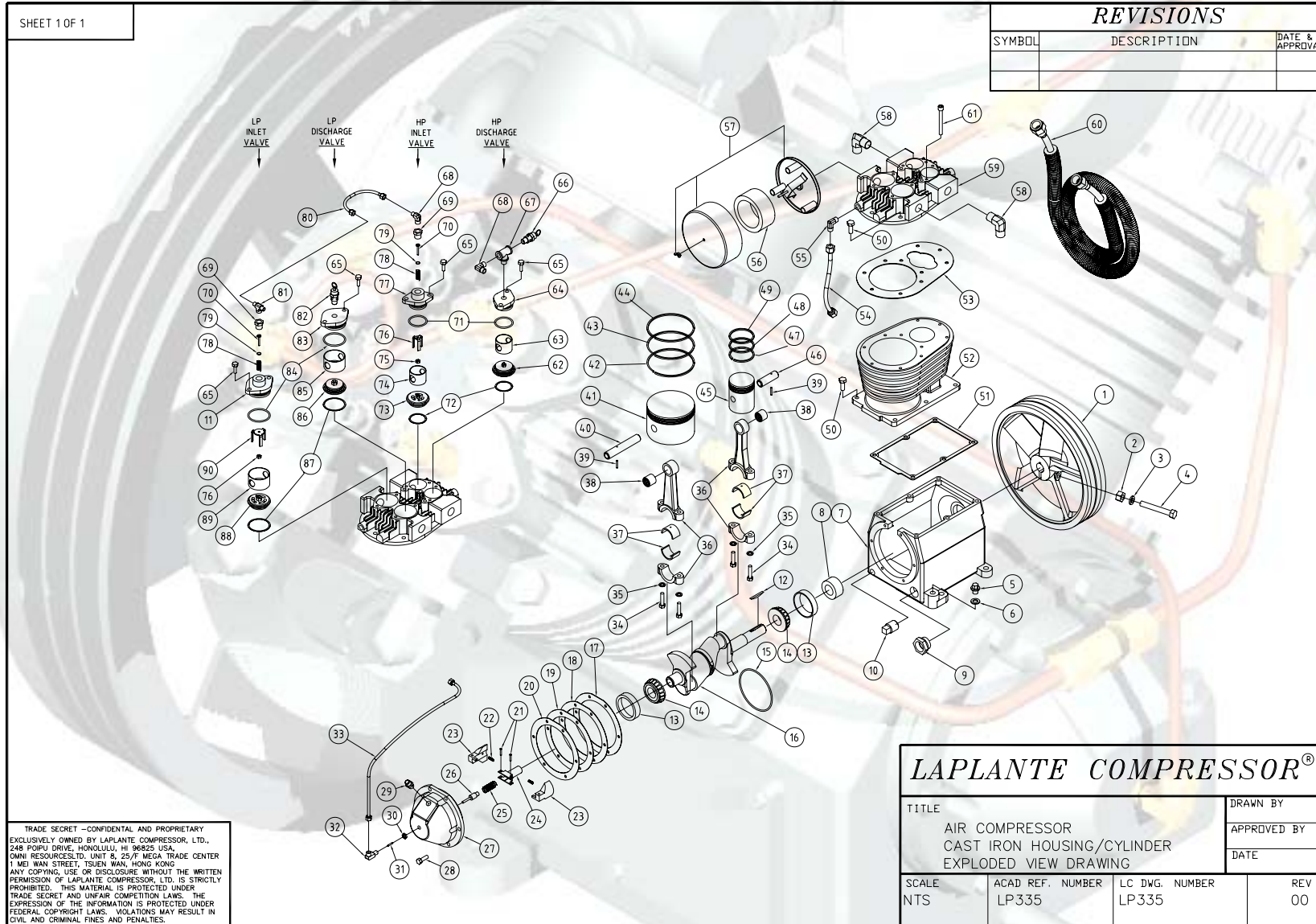

Bill of material list

LP335 Parts List							
Item	LAP#	Description	QTY	Item	LAP#	Description	QTY
A	010013	Overhaul Kit:Include 1 of Item 56,57,B,C,D		48	719033	Bottom Compression Ring HP	1
B	010014	Ring Set:Include 1 of Item 42,43,44,47,48,49		49	719032	Top Compression Ring HP	1
C	010015	Valve Set:Include 1 of Item 62,73,86,88		50	110131	SKT Head Capscrew 5/16-18X1	2
D	010016	Gasket Set:Include 1 of Item 17,18,19,20,51,53		51	070187	Base Gasket	1
1	713007	Flywheel 13.75" 2B	1	52	711004	Cylinder	1
2	120066	Fly Wheel Nut 1/2-13	1	53	070190	Head Gasket	1
3	130076	Flywheel Lockwasher 1/2	1	54	725003	Breather Tube	1
4	110133	Pulley Bolt 1/2-13x3 1/2	1	55	718016	Elbow Breather Connector	1
5	140038	Oil Filler Plug	1	56	712134	Filter Element	1
6	140036	Oil Filler Plug Gasket	1	57	712113	Filter	1
7	708008	Base And Cup Assembly	1	58	718011	Intercooler Connector	2
8	060300	Seal Oil	1	59	710002	Cylinder Head	1
9	714004	Oil Level Sight Glass; Copper	1	60	706006	Intercooler Assembly	1
10	140037	Oil drain Plug 3/8" NPT	1	61	110127	Head Bolt 5/16-18x1	8
11	726003	Hold Down Cover LP Inlet	1	62	727034	Valve Assembly LP Discharge	1
12	080033	Woodruff Key #26	1	63	727021	Cage L.P. Discharge	1
13	050800	Cone Bearing	2	64	110139	Hold Down Cover HP Discharge	1
14	050801	Bearing	2	65	110128	Hex head Capscrew 5/16-18x3/4	8
15	709008	Oil Feeder Ring	1	66	722008	Safety Valve	1
16	709100	Crankshaft & Taper bearing (inc. c	1	67	718202	T-Fitting(1/4x1/4(M)X1/4)	1
17	070185	End Cover Gasket .005	2	68	718012	Tube Ell. 1/4X1/4 NPT	1
18	070191	End Cover Gasket .006	1	69	718013	Bushing 3/8 NPT x 1/4 NPT	2
19	070291	End Cover Gasket .003	2	70	726004	Plunger	2
20	070186	End Cover Gasket .0015	2	71	060075	O Ring LP Cover	2
21	110129	Rivet	2	72	070189	Valve Gasket HP	2
22	723007	Bumper Spring	2	73	727023	Valve Assembly LP Inlet	1
23	728006	Weight Unloader	2	74	727020	Cage LP Inlet	2
24	726010	Holder Unloader	1	75	120068	Locknut	2
25	723008	Spring	1	76	726007	Fingers H.P.	1
26	726002	Plunger	1	77	726006	Hold Down Cover HP Inlet	2
27	701011	End Cover	1	78	723011	Spring	2
28	110126	End Cover Capscrew 5/16-18x1	6	79	060076	O Ring Plunger	2
29	718006	Breather Connector	1	80	725006	Unloader Tube	1
30	120069	Locknut	1	81	718014	Tube Tee 1/4x1/4x1/4 NPT	1
31	725005	Unloading Tube	1	82	722009	Safety Valve	1
32	727040	Elbow Valve & Unloader	1	83	727058	Hold Down Cover LP Discharge	1
33	725005	Unloading Tube	1	84	060074	O Ring HP Cover	2
34	110124	Rod Bolt 5/16-24 x 1 3/8	4	85	727025	Cage HP Discharge	1
35	130073	Lockwasher 5/16	4	86	727038	Valve Seat HP Discharge	1
36	705202	Connecting Rod	2	87	070188	Valve Gasket LP	2
37	050148	Bearing Inserts	4	88	727039	Valve Assembly Hp Inlet	1
38	050146	Needle Bearing Wristpin LP & HP	2	89	727022	Cage HP Inlet	1
39	100103	Rollpin LP &HP	1	90	726005	Fingers L.P.	1
40	729003	Wristpin LP	1				
41	719031	Piston LP	1				
42	719034	Oil Conrol Ring LP	1				
43	719030	Bottom Compression Ring LP	1				
44	719029	Top Compression Ring LP	1				
45	720006	Piston HP	1				
46	729004	Wristpin HP	1				
47	719142	Oil Control Ring HP	1				

Installation Instruction

1. Inspection

Check for possible damage in transit and see that the pulley turns freely by hand Report any damage to delivering carrier at once.

2. Location

Select a clean, dry and light location. In cold climates the compressor should be installed in a heated building Insulate cold water or other low temperature pipes that pass overhead to avoid the possible collection and dripping of condensate onto the compressor and motor which could cause rusting and or motor shorting Do not install the compressor in a boiler room, paint spray room or area where sandblasting is carried on. If air in the area where the compressor is to be installed is acid-laden, or dust laden the compressor intake should be piped to the outside This intake pipe should be increased one pipe size for every twenty (20) feet of run and the intake filters should be installed at the end of the pipes with a hood to protect them from the elements.

If the compressor has to be located where the motor will be exposed to appreciable quantities of water, oil dirt, acid or alkaline fumes the motor must be of special construction to avoid rapid deterioration.

Bolt the unit securely and evenly to a level base. Unless base is exactly level, shims will probably be required. Any space between base and foot should be shimmed rather than drawing foot down thus placing strain on unit. When the unit is properly shimmed vibration will be nominal.

Allow sufficient space around compressor so that it is accessible from all sides for maintenance. Mount unit with pulley side toward the wall. but at least six (6) inches from it.

3. Starting

A. If compressors are shipped without oil in the crankcase. Before starting, fill crankcase to the high level mark on the sight glass with LaPlante compressor oil meeting the following specifications.

AMBIENT OR ROOM TEMP. °F	VISCOSITY AT 100° F S.S.U.	FLASH POINT °F (Min.)	POUR POINT °F (Min.)	CARBON RESIDUE %o (Max.)	PREFERRED BASE
55 to 120	490 to 600	430	• 20	15	Naphthenic
32 to 55	290 to 350	390	* 5	10	Naphthenic
0 to 32	160 to 230	350	-10	.05	Naphthenic
Above 120 or below 0	CONSULT FACTORY				





For operation in damp or humid locations, addition of rust inhibitor is recommended.

B. Turn compressor over a few revolutions by hand to make sure that everything is free and in running condition.

C. Check tension of the belts (See Paragraph 6).

D. Remove tools, rags and any other objects from the vicinity of the compressor.

E. Never put hands on the belts of idle units, unless main power is secured.

F. Note direction of arrow on flywheel and be sure direction of rotation is correct when machine is started. Correct direction is counter-clockwise when standing facing the flywheel. Air should be drawn through inter-cooler onto the cylinders for maximum cooling



Head unloader

Cylinder Head and Inlet Valve Unloader Assembly Detail:

Explode drawing

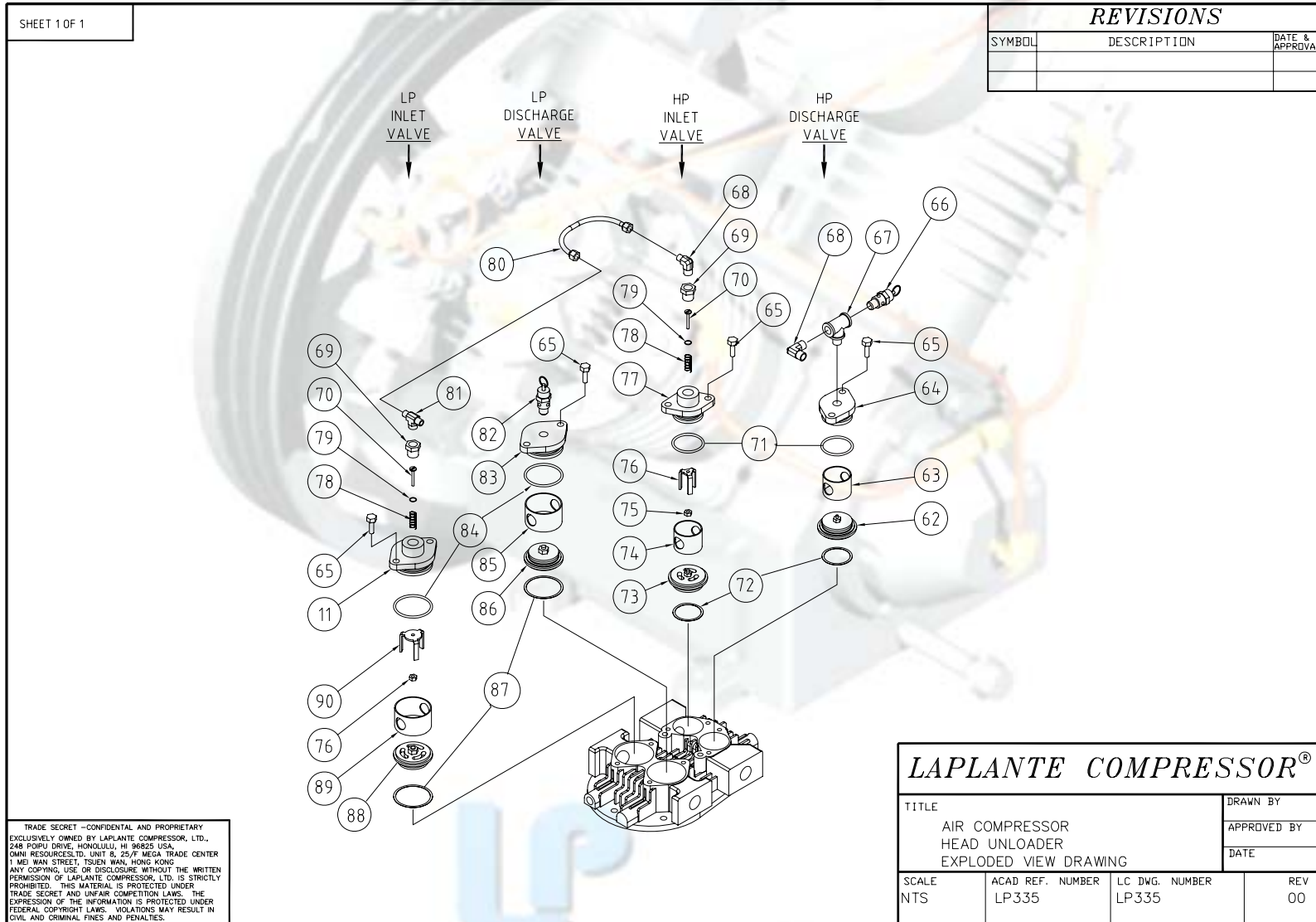

Bom list

LP335 Head Unloader Parts List			
Item	LAP#	Description	QTY
11	726003	Hold Down Cover LP Inlet	1
62	727034	Valve Assembly LP Discharge	1
63	727021	Cage L.P. Discharge	1
64	110139	Hold Down Cover HP Discharge	1
65	110128	Hex head Capscrew 5/16-18x3/4	8
66	722008	Safety Valve	1
67	718202	T-Fitting(1/4x1/4(M)X1/4)	1
68	718012	Tube Ell. 1/4X1/4 NPT	1
69	718013	Bushing 3/8 NPT x 1/4 NPT	2
70	726004	Plunger	2
71	060075	O Ring LP Cover	2
72	070189	Valve Gasket HP	2
73	727023	Valve Assembly LP Inlet	1
74	727020	Cage LP Inlet	2
75	120068	Locknut	2
76	726007	Fingers H.P.	1
77	726006	Hold Down Cover HP Inlet	2
78	723011	Spring	2
79	060076	O Ring Plunger	2
80	725006	Unloader Tube	1
81	718014	Tube Tee 1/4x1/4x1/4 NPT	1
82	722009	Safety Valve	1
83	727058	Hold Down Cover LP Discharge	1
84	060074	O Ring HP Cover	2
85	727025	Cage HP Discharge	1
86	727038	Valve Seat HP Discharge	1
87	070188	Valve Gasket LP	2
88	727039	Valve Assembly Hp Inlet	1
89	727022	Cage HP Inlet	1
90	726005	Fingers L.P.	1

Operation

The inlet valve unloaders are designed to provide **CONSTANT SPEED CONTROL** by holding open the inlet valves in both cylinders. When the air supply exceeds the demand and the discharge pressure rises above the maximum required, the pilot valve (not shown) admits air at discharge pressure to a plunger in each unloader, holding the inlet valve discs off their seats. Thus the air drawn into the cylinders is freely discharged without being compressed. When the pressure has dropped to the desired minimum, the pilot valve closes, allowing the inlet valves to seat and compression to be resumed.

Safety information



Please observe the following instructions when performing any maintenance, cleaning, repair work; when relocating the compressor plant; prior to installing and dismantling component parts, receivers, fittings and screw connections.

- Always isolate the compressor at the main switch prior to performing any maintenance work. Secure the main switch against accidental switching on! Remove the electrical fuses in order to avoid accidents!
- Depressurize the compressor!

Disconnect from the compressed air network by closing the ball valve on the compressed air outlet.

Perform maintenance or servicing work.

Only allow skilled and qualified welders to perform welding work on compressed air receivers!

After welding work on compressed air receivers, new constructional and hydrostatic pressure tests are to be carried out.

- Prior to switching on again, check whether anyone else is working on the compressor!

For your own safety, never omit a safety step!

Otherwise you will risk injury from restarting, electric shock or parts which may fly off!



Important!

Before do any install and maintenance work must be clean pump and parts!!

Installation

Place seat gaskets (72 & 87), valves (62,73,86 & 88) and cages (63,75,85 & 89) into head in sequence as shown. Install "O" ring (79) on plunger (70) and assemble with spring (78) into inlet hold-down cover (11 & 77) . Assemble fingers (76 & 90) and locknut (76) to complete assembly.

Install hold-down cover assemblies with "O" rings (71 & 84) using cap screws (70). Tighten evenly to a torque of 10 foot lbs. Connect unloader tube (80) to tube elbow (68) and tube tee (81). Connect tubing from pilot valve to tube tee (81).

Lubrication

When assembling plunger, (70) and "O" ring (79) to hold-down cover (11&77), coat "O" ring with silicon grease to facilitate assembly.

Service

Dirt in unloader line or defective pilot valve could hold valve open allowing unloading fingers to keep inlet valves open. Sometimes tapping the pilot valve will allow pilot valve to resume normal operation. If not, remove, clean or replace. Also broken "O" ring (79) may cause erratic operation. Refer to unloader pilot operation and maintenance details.



IMPORTANT: When ordering give **MODEL** and **SERIAL NUMBERS** of compressor.



Centrifugal Unloader
Explode drawing

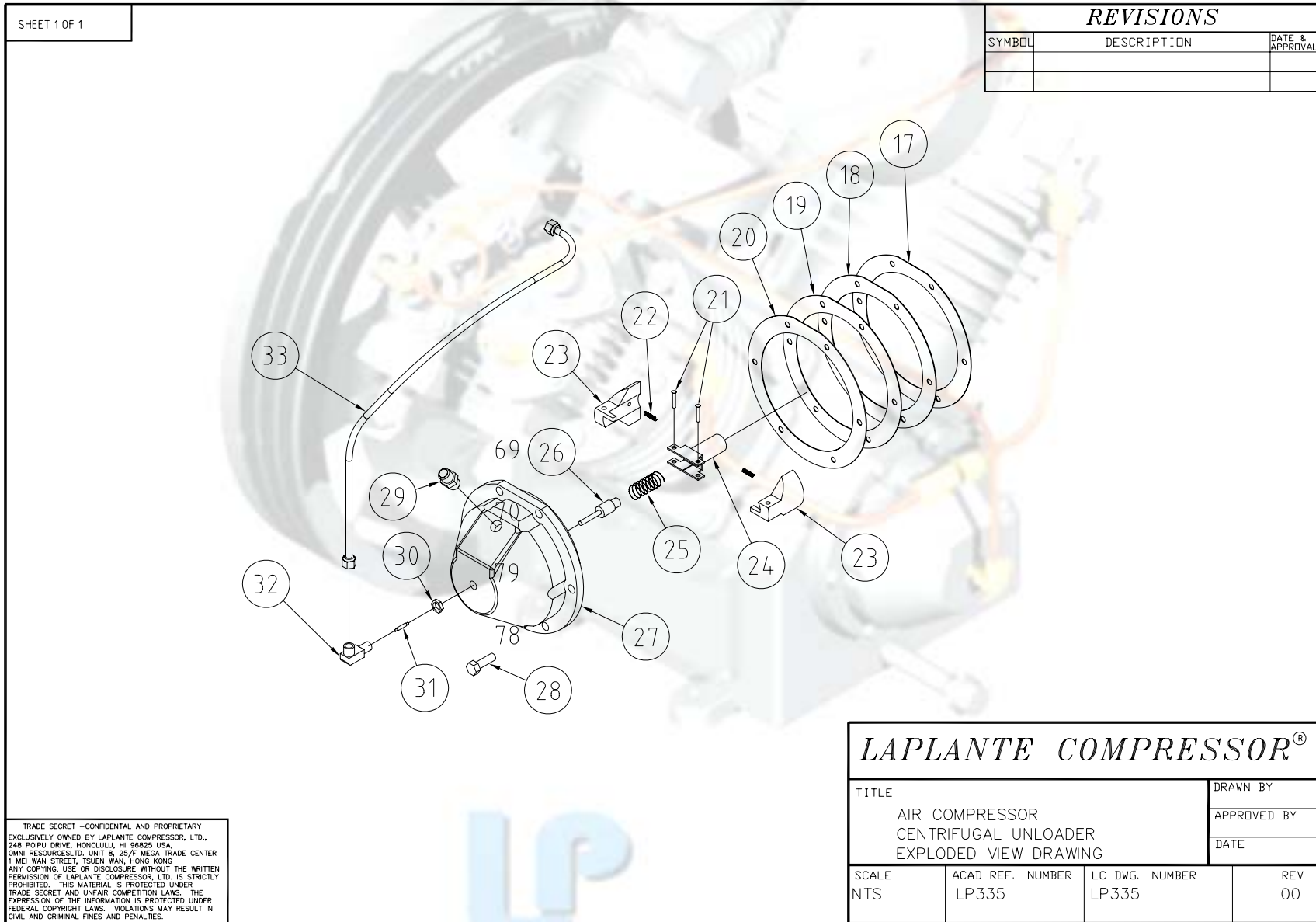

Bom list

LP335 Centrifugal Unloader Parts List			
Item	LAP#	Description	QTY
17	070185	End Cover Gasket .005	2
18	070191	End Cover Gasket .006	1
19	070291	End Cover Gasket .003	2
20	070186	End Cover Gasket .0015	2
21	110129	Rivet	2
22	723007	Bumper Spring	2
23	728006	Weight Unloader	2
24	726010	Holder Unloader	1
25	723008	Spring	1
26	726002	Plunger	1
27	701011	End Cover	1
28	110126	End Cover Capscrew 5/16-18x1	6
29	718006	Breather Connector	1
30	120069	Locknut	1
31	725005	Unloading Tube	1
32	727040	Elbow Valve & Unloader	1
33	725005	Unloading Tube	1

Operation

The centrifugal unloader is designed to give "loadless" starting to the compressor units to which it is applied. When the current to the motor is interrupted or if the pump stops, for any reason, the centrifugal unloader will release the air in the aftercooler and head. When the unit resumes operation, the unloader valve closes allowing a build up of tank pressure. **WARNING** — When using 3 phase motors be sure of proper rotation or weight retainer assembly will work loose in a very short time. Test motor rotation without belts assembled. Correct rotation is counter-clockwise when facing flywheel side.

Safety information



Please observe the following instructions when performing any maintenance, cleaning, repair work; when relocating the compressor plant; prior to installing and dismantling component parts, receivers, fittings and screw connections.

- **Always isolate the compressor at the main switch prior to performing any maintenance work.**

Secure the main switch against accidental switching on! Remove the electrical fuses in order to avoid accidents!

- **Depressurize the compressor!**

Disconnect from the compressed air network by closing the ball valve on the compressed air outlet.

Perform maintenance or servicing work.

Only allow skilled and qualified welders to perform welding work on compressed air receivers!

After welding work on compressed air receivers, new constructional and hydrostatic pressure tests are to be carried out.

- **Prior to switching on again, check whether anyone else is working on the compressor!**

For your own safety, never omit a safety step!

Otherwise you will risk injury from restarting, electric shock or parts which may fly off!



Important!

Before do any install and maintenance work must be clean pump and parts!!

Installation

The centrifugal unloader weight retainer assembly (21, 22, 23, 24 & 25) may be assembled to crankshaft in either of two methods. Preferred method is by mounting to crankshaft when crankshaft is removed from base during assembly of pump.

The second method is used when only the centrifugal unloader is to be dismantled and only end cover (27) is removed, then centrifugal unloader weight retainer assembly (21, 22, 23, 24 & 25) may be assembled when crankshaft is in base. Assemble assembly into tapped hole in crankshaft (L. H. Threads). Apply wrench to weight retainer (5) to tighten snugly. Do not bend wings of weight retainer. Assemble end cover (27) end cover gaskets (17, 18,19 & 20) to pump base with capscrews (28). Check end play of crankshaft in accordance to pump part sheet instruction. Insert plunger (26) into valve elbow assembly (30, 31 & 32) and screw into end cover until part of valve (31) can be seen when looking into tube opening of elbow (32). Do not screw elbow into end cover too far or unloader will not operate properly. Secure valve elbow assembly in position by tightening jam nut (30).

Connect unloader tube (33) to elbow in high pressure discharge hold-down cover and valve elbow (32). Connect breather tube to elbow in head and to straight connector (29) in end cover.

Lubrication

When assembling unloader unit, plunger (26) and rivets (21) with good grade of machine oil.

Service

Leakage of air out through the unloader valve elbow opening after the unit has been shut off for a time, is an indication of a check valve leak and should be corrected by repair or replacement.



IMPORTANT - When ordering, give MODEL and SERIAL NUMBERS of compressor.

Operation

Every compressor undergoes a trial run in the factory and is carefully tested and set. However, damage occurring afterwards, e.g. during transport, cannot be excluded. Therefore, the compressor should always be subjected to a trial run during commissioning and carefully monitored.



Before start pump must be do the following job first!!!

**Check power supply and ;
Check oil level; top up if necessary;
Check fastener and piping connection;**

For 3-phase power:

Ensure no problem; start-up pump to check rolling direction, counter-clockwise is right, if not, please change 2 of 3-phase power wiring.

If all items are ok, start the pump in operating.



Parts Kits

About parts kits of pump include 4 sets:

1. Overhaul Kit: Includes 1 each of filter element and ring set, valve set, gasket set.
2. Ring Set: Includes 1 set of piston rings.
3. Valve Set: Includes 1 set of inlet valve and outlet valve.
4. Gasket Set: Includes 1 each of gasket.



For each pumps you can find the relevant parts kits number and describe in the explode drawings and bom list section.

Safety information



Please observe the following instructions when performing any maintenance, cleaning, repair work; when relocating the compressor plant; prior to installing and dismounting component parts, receivers, fittings and screw connections.

- Always isolate the compressor at the main switch prior to performing any maintenance work.

Secure the main switch against accidental switching on! Remove the electrical fuses in order to avoid accidents!

- Depressurize the compressor!

Disconnect from the compressed air network by closing the ball valve on the compressed air outlet.

Perform maintenance or servicing work.

Only allow skilled and qualified welders to perform welding work on compressed air receivers!

After welding work on compressed air receivers, new constructional and hydrostatic pressure tests are to be carried out.

- Prior to switching on again, check whether anyone else is working on the compressor!

For your own safety, never omit a safety step!

Otherwise you will risk injury from restarting, electric shock or parts which may fly off!

Bolt torque chart

Bolts Size	Grade	Torque(Ft.-Lb.)	Position
1/4-28 NF	8.8	8	LP. Valve Nut
3/8-24 NF	8.8	40	Cylinder to Base Bolt
5/16-18 NC	8.8	10	Head to Cylinder Bolt
	10.9		Connecting Rod Bolt
	8.8		LP & HP Hold Down Bolt
5/16-24 NF	8.8	12	Flywheel Bolt
7/16-14 NC	8.8	43	Cover Bolt

Disassembling Pump

Before dismantling a pump for overhauling it is advisable to obtain a set of valve parts, piston rings, and gaskets in addition to other required parts.

- A. Loosen motor, slide toward pump and remove belts. Drain oil from crankcase and if desired, remove complete pump from plat form.
- B. Remove flywheel bolt and remove pulley using a wedge or wheel puller if required. Remove key File edges of key way smooth to remove sharp edges which could cut oil seal during removal.
- C. Remove intercooler and aftercooler from cylinder head. Remove air inlet filter from head.
- D. Remove cylinder head from cylinder by removing cap screws.
- E. Before removing cylinder mark top of pistons nearest flywheel, so that they can be reinstalled in same position. Remove cylinder by removing bolts Cylinder can be removed easily by twisting slightly back and forth while pulling upward. Care should be taken that connecting rod and piston does not become damaged from striking metal when cylinder is removed The condition of cylinder, pistons, rings and bearing fits can then be checked.
- F. Remove end cover and slide crank shaft with connecting rods, pistons, etc. out of base being careful not to damage the oil feeder ring. Place pulley end of crankshaft in a vice using a soft jaws to prevent damage.
- G. To remove pistons. Remove roll pins, by driving them into the wrist pins, and push out wrist pins. Remove roll pins from wrist pins.
- H. When removing connecting rods see that rods and caps are kept in matched sets, noting the position with reference to the crankshaft of the identification marks on one side of each so that

the connecting rod can be replaced in the same position it originally occupied.

- I. Drive oil seal out of base (only if replacement is necessary) with evenly spaced blows from inside.
- J. To dismantle head, remove low pressure hold-down covers and high pressure hold-down covers by removing cap screws. Lift out low pressure cages and high pressure cages. Low pressure valves and high pressure valves can be lifted out as well as the low pressure seat gasket (15. fig. 4) and high pressure seat gasket.
- K. To dismantle valves, place valve in a soft jaw vise and remove center screw. Valves are now free to take apart. Clean all parts thoroughly. Valve plates and seats- (must be smooth and flat and can sometimes be resurfaced by rubbing on fine emery cloth held on a smooth surface. Badly worn parts including springs, which lose tension after considerable use should be replaced.

Fitting and Reassembling



Clean all parts thoroughly before assembling.

A. Crankshaft — Base

Be sure base is cleaned to remove all metal chips and dirt. Insert crankshaft and oil feeder ring only into base assemble end cover and tighten end cover bolts evenly. End cover gaskets or shims are furnished in three thicknesses and the proper combination must be selected so that crankshaft can be "spun" in the bearings without "end play". Also see that oil feeder ring turns freely within the guide lugs in the base. Then remove crankshaft.

B. Piston — Cylinder

Check fit before assembling pistons to connecting rods. Pistons without rings should slide through the cylinder of their own weight and holding the skirt of the piston with the two thumbs there should be no appreciable side motion at any point of piston travel. Scored cylinders or pistons should be replaced. C. Wrist Pins should be "tap" fit by hammer. See that roll pin holes are in line.

D. Wrist Pin — Needle Bearing

Fit so that piston can be "rocked" with three fingers — the thumb on one side and index and middle fingers on the other. The piston should not rock of its own weight. Drive roll pin into wrist pin when piston and wrist pin holes are in line and piston is assembled to connecting rod. If replacement of a needle bearing ever becomes necessary, be sure to press in the new bearing so that the small hole through casting lines up with oil hole in rod. Wrist pin should also be replaced.

- E. Connecting Rod — Crankshaft Tap cap, when insert bearings are assembled to rod and cap to make sure bearing is making contact and tighten rod bolts with lock washers in place to prevent loosening (torque — 25 foot pounds). The combined piston and connecting rod should turn slowly on the crankshaft of their own weight if bearing adjustment incorrect. It will be noted that ends of the inserts extend slightly above the parting line of the rod and cap and under no circumstance should these ends of the inserts be filed.

- F. Reinstall crankshaft with pistons and connecting rods attached being careful not to damage oil feeder ring when fitting within base lugs and being sure there are no burrs or dirt on the pulley end of the crankshaft that might cut the oil seal.
- G. If oil seal is to be replaced slide over the crankshaft and press into place in the base, the lip or seal side toward the crankcase. Do not hammer directly on the seal.
- H. Replace valve parts in sequence indicated in explode drawing being careful not to force any parts together when tightening this center screw (11).and locknut (Torque — 28 foot — pounds). After assembly .depress valve plate to insure that the valve works freely.
- I. Head Assembly
Install seat gaskets valve assemblies Cages, "O" rings, Hold down covers and cap-screws. Tighten cap screws evenly so as not to break corners of hold down covers (Torque — 10 foot — pounds), Assemble head to cylinder (Torque -10 foot - pounds).
- J. Install key and pulley after cylinder head, intercooler and after-cooler are connected.
- K. Turn pulley over by hand several times to insure that no interference of any kind exists.
- L. "Running in" for a few hours without the head assembly is recommended if a pump has been completely overhauled — especially if new pistons and/or cylinders have been installed.

Valves

Valves are generally considered to be maintenance items and require care by the user. They are the most important part of the compressor and the importance of proper care and maintenance cannot be over-emphasized.

All valves should be removed from the cylinder head at the end of the first two or three months of operation and examined for cleanliness and carbon formation. Clean with safety solvent and blow off with compressed air. Depending on what is found at this inspection, the next inspection should not be more than 4 to 6 months later. These 2 inspections will guide you in scheduling periodic cleaning times which will pay off many times over in providing trouble free service and reduced down time.

Troubleshooting

1. Slow Pumping Or Insufficient Pressure Can Be Caused By

- A Clogged inlet filter — (Disassemble and clean thoroughly.)
- B Leaks in air lines, valves, fittings, etc. (Locate using soapy water if necessary: replace or tighten threaded parts.)
- C Compressor too small for equipment being operated — (Check air requirements and add to compressor capacity — consult dealer.)
- D Leaking head valves - (Remove hold-down covers and remove valves for examination. Repair or replace faulty valves.) Valves can be removed from head by tapping valve screw with hammer handle or piece of wood, to loosen valve from head, before lifting valve.
Clean all parts thoroughly. Valves and seats must be flat and smooth and sometimes can be resurfaced by rubbing on fine emery cloth held on a smooth flat surface. Badly worn parts, including springs which lose tension after considerable use should be replaced Reassemble

valve parts in sequence indicated in explode drawing. Examine valve gaskets carefully and replace if doubtful of condition. Be careful that nothing falls into the cylinder that could get caught between top of piston and cylinder head. Before reassembling valve look into cylinder through valve opening while turning flywheel by hand.

2. Excessive Oil Consumption

"Oil Pumping" usually results from using the wrong type or an inferior grade of oil. Replacing worn or stuck piston rings will help correct this condition but contrary to popular belief, worn rings do not affect pumping efficiency appreciably.

Piston rings can be replaced by removing cylinder while the heads are off. Remove rings and clean grooves in piston.

The low pressure oil ring provided is of the latest design and is the same as furnished on the new automobile engines. It is of three-piece construction with two chrome-plated rails and an expander ring. Some new units may pump a slight amount of oil for a period of time but as the chrome-plated rails seat to the cylinder walls this will gradually diminish. Should excessive oil consumption continue, the cylinders should be checked for scoring and the oil ring checked for proper assembly. The two ends of the expander rings are colored with paint for identification and when properly assembled should be butted, not overlapped. The high pressure oil ring is of the one piece construction.

A coating of clean oil should be placed on the rings and the inside of the cylinders for ease of assembly and to minimize possibility of scoring cylinder. See Paragraph 16 for reassembly procedure.

3. Noisy Operation Can Be Caused By

- A. Loose parts — external — (Tighten loose bolts, particularly the flywheel pulley to the crankshaft.)
- B. Foreign matter such as carbon, metal chips, etc. on pistons striking head at top of stroke (Remove head and clean).
- C. Piston extending above cylinder at top of stroke and hitting head. (Remove cylinder and add base gasket, not upper cylinder gasket.)
- D. End play in crankshaft — (Remove end cover, take out one end cover gasket or shim and replace). Do not remove too many shims or binding may result, see Paragraph under fitting and reassembling.
- E. Loose valves — Hex head cap screws are not tight enough. (Tighten screws)



Screws should be tightened snugly but not too tight as hold-down cover corners could be broken. Screws should be tightened evenly keeping covers parallel with cylinder head. Screws have nylon insert in threads and are of self-locking construction. They will not loosen from vibration and can be removed and retightened several times without losing their holding ability.

F. Loose or worn parts — Internal, e.g. pistons, connecting rods, wrist pins, valves — (Pump

should be overhauled — preferably in distributors service department or factory. Loose rod bolts can be tightened after removing crankshaft, but if bearings are worn or scored, new insert bearings must be installed.)

4. Oil Leak

At base or end cover gasket — (Disassemble at point of leak, shellac or perma-gasket on both sides and reassemble. Maintain correct oil level).

5. Vibration

Characteristic of all reciprocating machines. can be held to a minimum by keeping the compressor securely fastened to a solid level foundation, maintaining proper belt alignment and keeping nuts and bolts tight.

6. Overheating

Compression of air generates heat, much of which is dissipated as air passes over the intercooler and/or aftercooler . Overheating can be caused by:

- A. Pump running backwards — (Reverse direction.) Proper rotation is counterclockwise facing flywheel.
- B. One or more head valves failing to seat properly — (Remove hold-down cover, valve cage, and valve. Clean, reseal or replace valves.)
- C. Blown cylinder head gasket — (Replace after cleaning all traces of old gasket from head and cylinder.) .
- D. Restriction in head, intercooler or check valve if used. — (Remove and clean.)
- E. Lack of oil — (Check oil level, if necessary, remove side plate to see that oil feeder ring is free to turn.)
- F. Dirt in intercooler fins or cylinder fins - (Blow out with air.)
- G. Poor ventilation and high room temperature
(If compressor cannot be moved, check possibility of piping intake to cooler location.)

7. Compressor Has No Or Insufficient Output

- A. Suction filter soiled-(Clean suction filter)
- B. Suction and pressure valves worn or defective-(Replace valves)
- C. Vent (unloading) valve does not close-(Check whether the vent (unloading) valve closes when the compressor is running; overhaul or replace valve, if necessary)

8. Safety Valve Of The First Stage Blows Off

- A. Suction and pressure valves of the second stage defective or worn-(Replace valves)
- B. Seal between valve and cylinder head defective-(Replace seal)

9. Oil Foam in The Crankcase

- A. Last stage piston worn-(Operate compressor with final stage valve head removed. If oil collects at rim of cylinder, piston clearance ok. If oil flows continuously out of cylinder, replace piston and liner)
- B. Last stage outlet valve defective-(Replace)

10. Oil out of from the breather

Compressor piston jammed-(Replace pistons and cylinders)

Maintenance



To obtain reliable and satisfactory service, this unit requires a consistent preventive maintenance program. Maintenance schedule pages are included in the back of this manual to aid in keeping the proper records.

General

1. Check your compressor regularly!
2. Check entire system for air leakage around fittings, connections, and gaskets, using soap solution.
3. Remove dust or oil soiling.
4. Check fastener tightness by using torque wrench to the corresponding values within this guide.

Safety information



Please observe the following instructions when performing any maintenance, cleaning, repair work; when relocating the compressor plant; prior to installing and dismounting component parts, receivers, fittings and screw connections.

- Always isolate the compressor at the main switch prior to performing any maintenance work.

Secure the main switch against accidental switching on! Remove the electrical fuses in order to avoid accidents!

- Depressurize the compressor!

Disconnect from the compressed air network by closing the ball valve on the compressed air outlet.

Perform maintenance or servicing work.

Only allow skilled and qualified welders to perform welding work on compressed air receivers!

After welding work on compressed air receivers, new constructional and hydrostatic pressure tests are to be carried out.

- Prior to switching on again, check whether anyone else is working on the compressor!

For your own safety, never omit a safety step!

Otherwise you will risk injury from restarting, electric shock or parts which may fly off!

Check oil level

Check oil level every week and top up, if necessary: fill the oil tank with oil until the sight glass is 1/4 to 3/4 full.



Oil sight glass



WARNING

Use the same brand oil

Check and clean compressor valves

if compressor fails to pump air or seems slow in filling up tank, disconnect unit from power source and remove valves and clean thoroughly, using compressed air and a soft wire brush. After cleaning exceptional care must be taken that all parts are replaced in exactly the same position and all joints must be tight or the compressor will not function properly. When all valves are replaced and connections tight, close hand valve at tank outlet for final test. Valve gaskets should be replaced each time valves are removed from pump. Replace springs, discs and seats when worn or damage.



CAUTION

Valves must be reinstalled in original position. Incorrect valve replacement may result in overpressure of the cylinder head resulting in catastrophic failure, injury or death. Valve gaskets should be replaced each time valve are serviced.

Checking the safety valve



DANGER

The safety valve must respond when the compressor pressure increases too high.

The inter stage pressure relief valve is provided to protect against inter stage over pressure and is factory set for maximum pressure of 75 PSIG. If the pressure relief valve pops open, it indicates trouble. Shut down the unit immediately and determine and correct the malfunction. Inspect the head valves. Serious damage can result if not corrected and can lead to complete destruction of the unit. Tampering with the inter stage pressure relief valve, or plugging the opening destroys the protection provided and voids all warranty.

The valve must be able to blow off the entire delivery quantity of the compressor. As it is rarely or never operated, it is of utmost importance for the safety of the compressor that the valve is regularly checked. Check the valve once a year or after 2000 operating hours.

This is the only maintenance work which has to be performed while the compressor is running. Make sure that all safety devices are correctly installed! Never perform this work with the safety device removed! Danger of injury or death!



Do not readjust!!

Test safety valve on compressor:

A ring is located at the free end of the safety valve. Pull the ring by hand. Never remove the lead seal at the head of the valve!

If you now pull the ring further, the safety valve should blow off increasingly more air.

If the valve blows off correctly, dropt hand tight in its seating and complete the check.

- If the valve does not blow off although you have pull the ring up to the end of the stud, it is defective. Please have a new safety valve fitted by **LAPLANTE** Service.

Test the valve as described in section "Testing safety valve on compressor".

Compressor Oil

General

Compressors are factory filled with **LAPLANTE** hydrocarbon based recip lubricant. This is an ISO non-detergent industrial lubricant with rust and oxidation inhibitors specially formulated for reciprocating compressors. It is recommended this compressor be maintained using this oil for ambient temperature above 32 F degreed.

LAPLANTE synthetic is a premium grade diester based synthetic lubricant providing excellent performance in high temperature applications.



Do not mix oil types, weights or brands.



Normal break-in period of **LAPLANTE** air compressors is 25 hours.
for the first 500 hours of compressor operation, a careful and regular check of the oil level should be made. Maintain oil level at the full time.

Change To Synthetic Lubricant

If changing to synthetic lubricant, the following steps must be completed.

Compressor must run for a 25 hour break-in period using LAPLANTE ISO 100 oil.

Thoroughly drain existing oil from crankcase.

Fill crankcase with a full charge of synthetic lubricant.

Run compressor for 200 hours.

Stop compressor and thoroughly drain the synthetic lubricant.

Add a full charge of synthetic lubricant.

Compressor now ready to run for extended period before next lubricant change made. Maintain oil level at the full line.

Lubricant

Frequency Of Oil Change

Change oil every 3000 operating hours whichever comes first. For constant run applications in daily use or units subjected to extremely heavy use change oil monthly.

Oil Recommendation



Any Approved Oil Which Is Equal To Those Specified May Be Used

Ambient Or Room Temperature 55° F To 120° F

AMOCO	SHELL	MOBIL	TEXACO	CHEVRON	GULF	EXXON
#51	Tellus Oil 41 Rotella Oil 30	Del vac 1230 DTE Heavy	Regal ER&O	EP68X	Paramount 58	Teresstic 100

Ambient Or Room Temperature 32° F TO 55° F

AMOCO	SHELL	MOBIL	TEXACO	CHEVRON	GULF	EXXON
#31	Tellus Oil 33 Rotella Oil 20-20W	Delvac 1220 DTE Heavy Med.	Regal CR & O	EP55X	Paramount 49	Teresstic 68

Ambient Or Room Temperature 0° F TO 32° F

AMOCO	SHELL	MOBIL	TEXACO	CHEVRON	GULF	EXXON
#21	Tellus Oil 25 Rotella Oil 10W	Delvac 1210 DTE Medium	Cetus Oil	EP45X	Paramount 65	Teresstic 32

Suction Filter

Regularly and carefully maintain the suction filter approx. every 500 operating hours, depending on the degree of soiling of the air taken in. Soiled suction filters can cause high oil consumption and reduced delivery quantity! If the installation site is heavily contaminated with dust, provide a dry air filter with paper cartridge. If the ambient air is heavily contaminated, we recommend using dry air filters.

All compressors are available with a common air filter with under pressure display for all cylinders.

Clean air filter

Nearly 1500 operating hours or 1 year

Check air filter and clean, if necessary

After undoing the snap fasteners, lift the cover off and take out the filter cartridge. If the filter is soiled, clean as follows:

Clean the cartridge on the outside by an inclined air blast at max. 3-5 bar.

The cartridges can be cleaned up to three times before being replaced with new ones.

Nearly 1500 operating hours or 1 year to change the filter element

Clean the filter casing.

Carefully inspect the cartridge for damage. Only use completely intact filters cartridges!

Examine cover seal and replace with a new one if damaged.

Insert filter cartridge, replace casing cover and close with fastening clamps.



Cleaning the air filter

Maintenance intervals

We recommend servicing and maintaining your compressor at the following intervals. The hours of operation refer to average working conditions. Other intervals may apply depending on these conditions. Please contact LAPLANTE in this event.



Please record each maintenance task in the table on the last pages of these instructions! This may help **LAPLANTE-Service** to locate faults if any occur.

Maintenance work	Maintenance intervals dependent on usage		
	either after	or	
	Operating hours	weekly / monthly	yearly
Check oil level and top up, if necessary		weekly	
Check suction filter and clean, if necessary	500	monthly	
Replace suction filter cartridge	2000		X
Check safety valve	2000		X
Check cooler for soiling and clean, if necessary	500	monthly	
Change oil *	1.000		every 1 years
Check V-belt for damage and replace, if necessary	2.000		X

Yamaha Engine

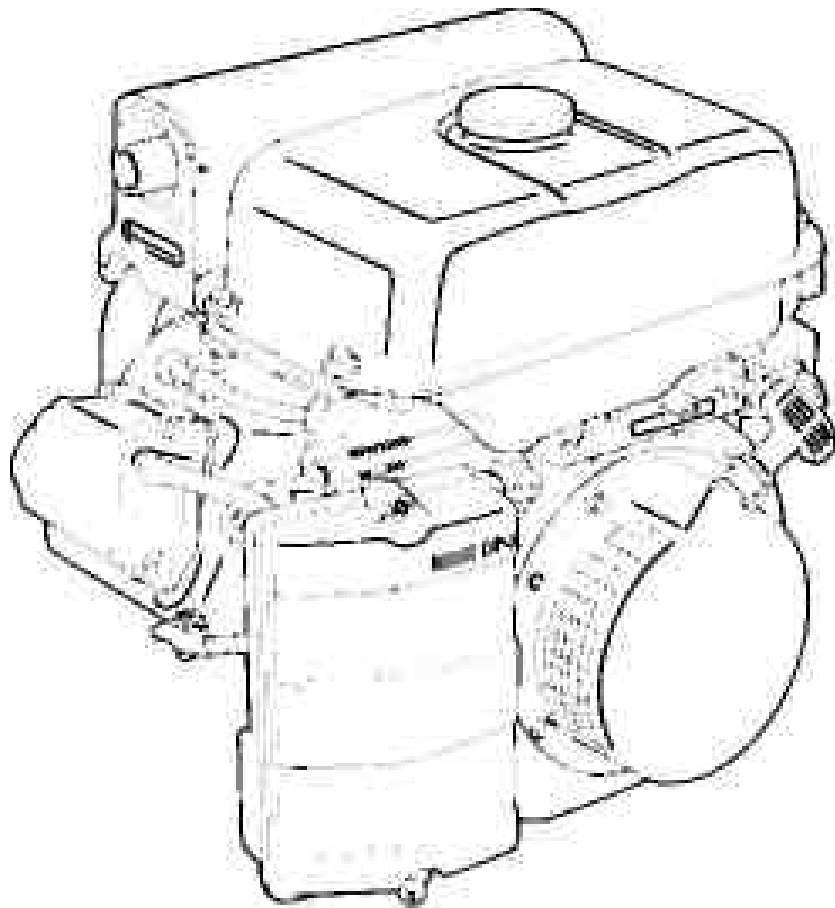

Safety information



Please observe the following instructions when performing any maintenance, cleaning, repair work; when relocating the compressor plant; prior to installing and dismantling component parts, receivers, fittings and screw connections.

- **Always isolate the compressor at the main switch prior to performing any maintenance work.**

Secure the main switch against accidental switching on! Remove the electrical fuses in order to avoid accidents!

- **Depressurize the compressor!**

Disconnect from the compressed air network by closing the ball valve on the compressed air outlet.

Perform maintenance or servicing work.

Only allow skilled and qualified welders to perform welding work on compressed air receivers!

After welding work on compressed air receivers, new constructional and hydrostatic pressure tests are to be carried out.

- **Prior to switching on again, check whether anyone else is working on the compressor!**

For your own safety, never omit a safety step!

Otherwise you will risk injury from restarting, electric shock or parts which may fly off!

SAFETY INFORMATION

EXHAUST FUMES ARE POISONOUS.

Never operate engine indoors.

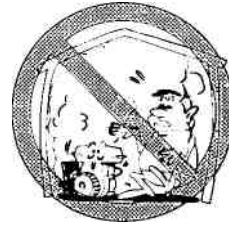

FUEL IS HIGHLY INFLAMMABLE.

Stop engine when refueling.



No smoking while refueling.



ENGINE AND MUFFLER ARE HOT.

Keep children away.

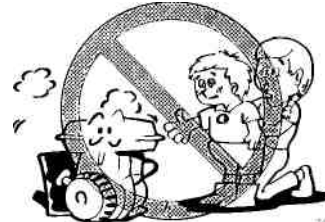

Take care not to spill fuel.



Avoid placing inflammables



Keep away more than 1 meter.

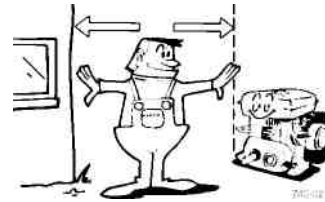

Do not operate with dust cover.

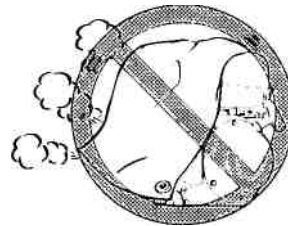

PRE-OPERATION CHECK

FUEL

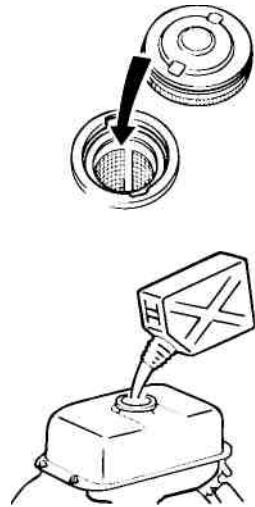

Recommended fuel: Unleaded gasoline

Fuel tank capacity

After refueling, tighten tank cap securely.

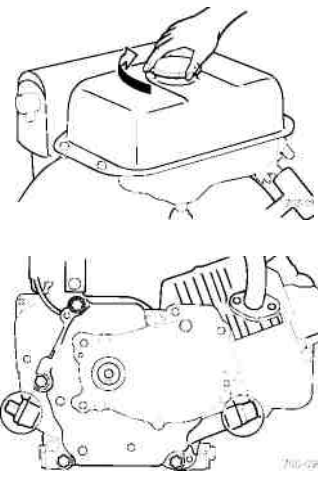

Do not fill above fuel filter top.

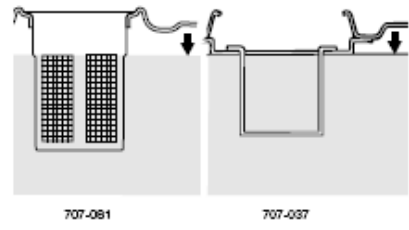

Check oil level on level surface.

- ① Upper level
- ② Lower level

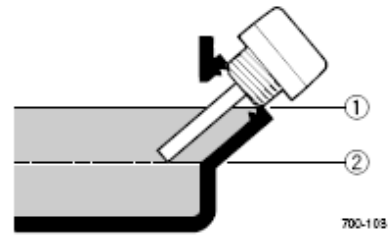

Add oil to upper level ①

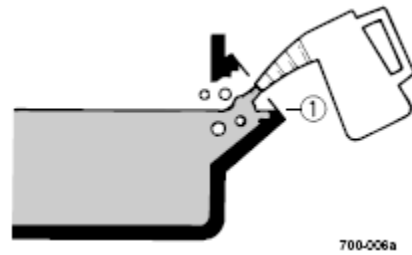

ENGINE OIL

Recommended oil

Above 35°C (95°F): SAE #40

API Service "SE" and "SF"

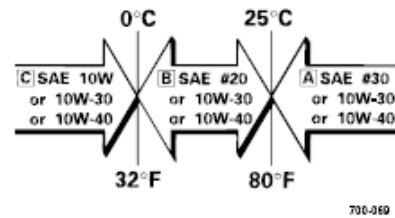

Battery (for electric starting model)

Recommended **battery capacity 12V/26A-h** or more.

1. Connect battery positive terminal and start switch

2. Ground battery negative terminal to engine mounting bolt ②

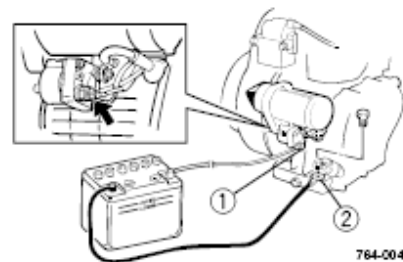

Use battery lead wires with cross section of at least 8 mm square.

STARTING THE ENGINE

Turn fuel cock lever to “ON” ①

Turn choke lever to ②

Move throttle lever slightly to ③

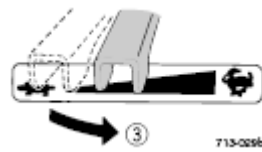
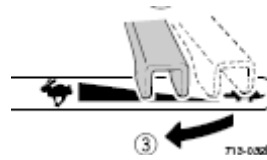
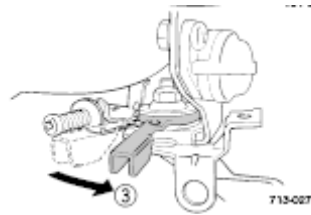
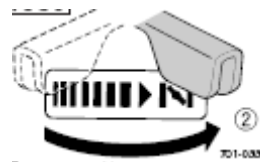
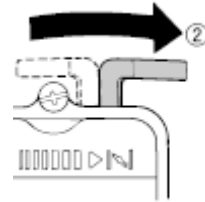
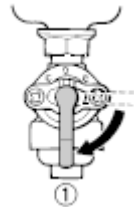

Manual starting model

Turn engine switch to “ON”

Pull slowly on recoil starter until engaged, then pull it briskly.

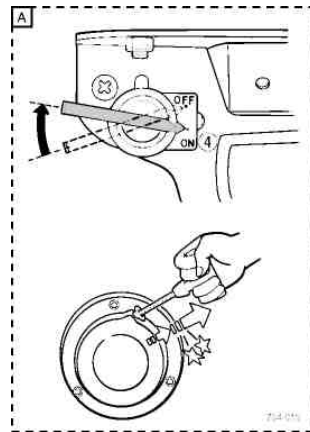

Electric starting model

Turn engine switch to ④

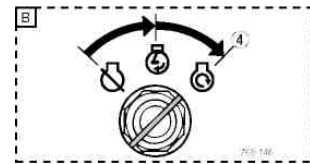

Return choke lever and set throttle lever in desired position.

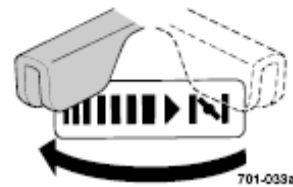
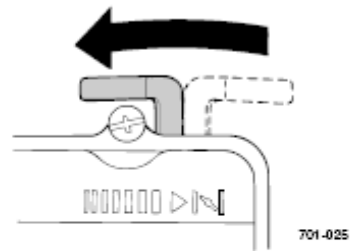

⑤. Decrease engine speed

⑥. Increase engine speed

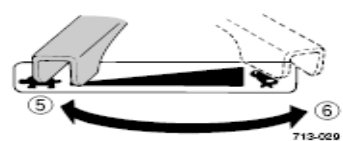
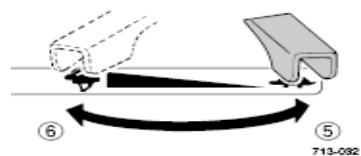
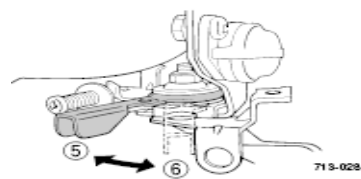

STOPPING THE ENGINE

Move throttle lever fully to ①

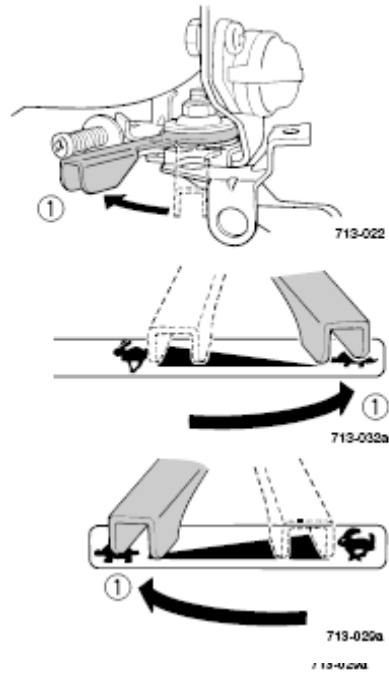

Turn engine switch to “OFF” ② 

Turn fuel cock lever to “OFF” ③

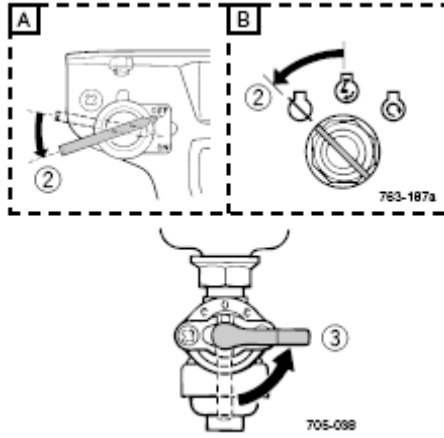

PERIODIC MAINTENANCE						
Item	Remarks	Preoperation check (daily)	Initial 1 month or 20 Hrs	Every 3 months or 50 Hrs	Every 6 months or 100 Hrs	Every 12 months or 300 Hrs
Spark Plug:	Remove carbon. Adjust gap. Replace if necessary.			•		
Engine Oil:	Check oil •					
	Replace.		•		•	
Air Filter:	Clean. Replace if			•		
Fuel Filter:	Clean. Replace if				•	
Valve clearance:	Check and adjust at Yamaha dealer.					•
Muffler screen/ Spark arrester:	Clean. Replace if necessary.				•	
Decarbonization:	Check and adjust at Yamaha dealer.					•

SPARK PLUG

1. Remove spark plug.



2. Remove carbon deposits.

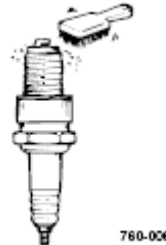

3. Check for discoloration.

Standard: Tan color

4. Check spark plug gap ①

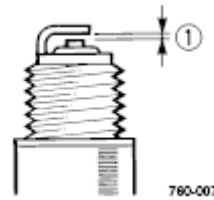

Standard spark plug type and gap.

BPR4ES (NGK)

- ① 0.7 - 0.8 mm (0.028 - 0.031 in)

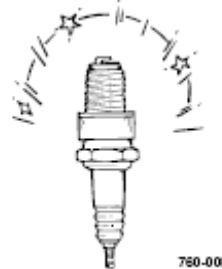

Engine oil replacement

1. Stop engine, and remove oil filter cap.

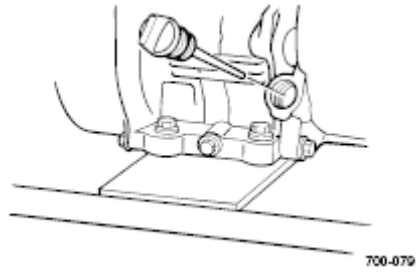

2. Remove oil drain plug and drain oil.
3. Reinstall oil drain plug.

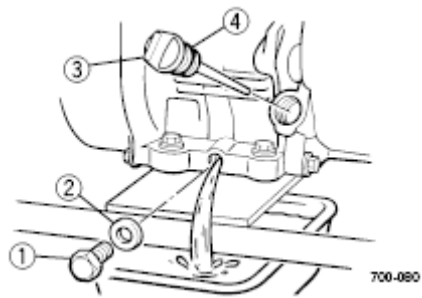

Add oil to upper level ①.

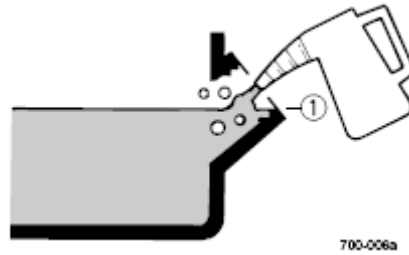

Recommended oil
Above 35°C (95°F): SAE #40
API service “SE” or “SF”

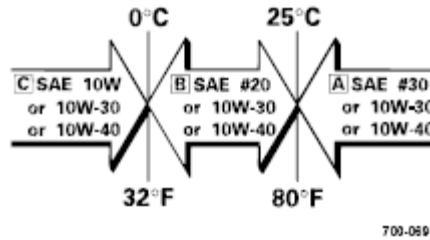

AIR FILTER

- ①. Air filter
- ②. Wash in solvent
- ③. Motor oil (SAE #20)
- ④. Squeeze out

Never run engine without element.

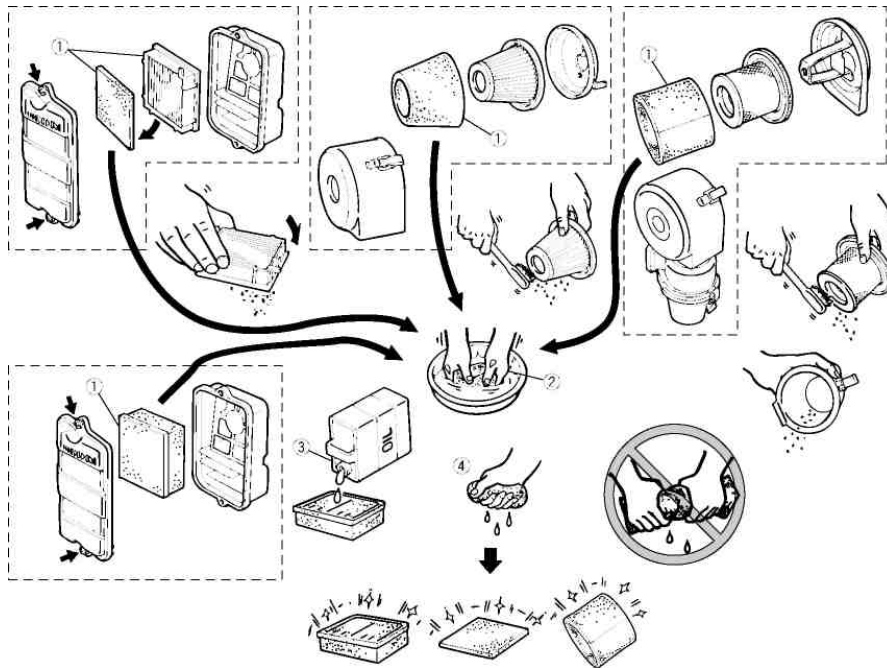

FUEL FILTER

- 1. Stop engine.
- 2. Turn fuel cock lever to "OFF".
- 3. Clean with solvent.

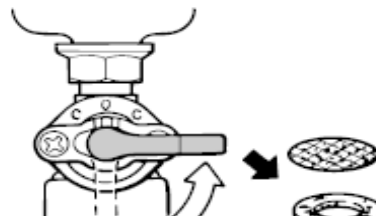

1. Clean in solvent.
2. Wipe off.
3. Insert.

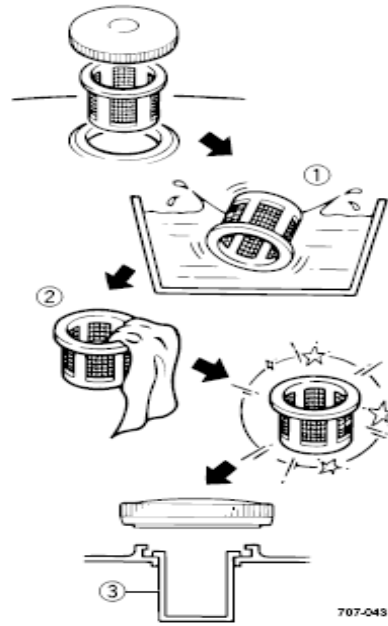

Muffler Screen

1. Remove Muffler Screen
2. Clean carbon deposits using wire brush
3. Install.

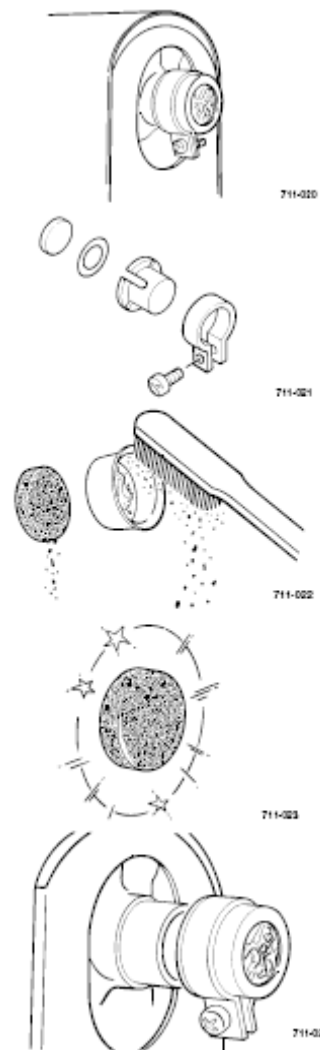

Sparker Arrester

1. Remove screw.
2. Remove spark arrester using flathead screw driver.
3. Clean carbon deposits using wire brush lightly.
4. Install

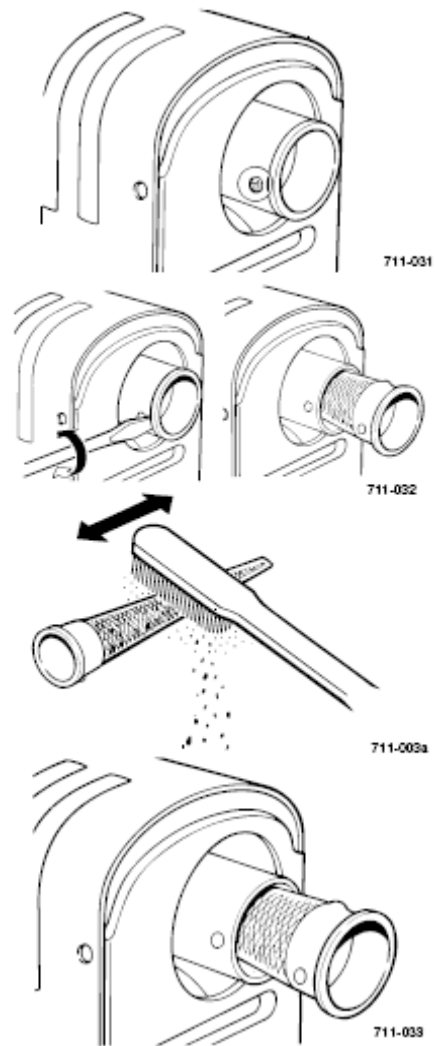

Fuse Replacement

For electric starting model

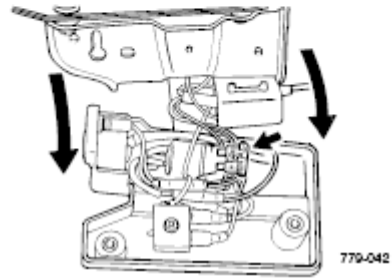
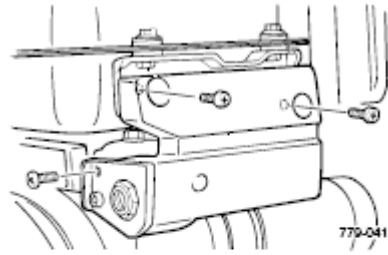
Fuse Type: **10A**

STORAGE

1. Drain fuel tank.
2. Drain fuel cock.
3. Drain carburetor
4. Replace engine oil
5. Store engine in clean, dry place.

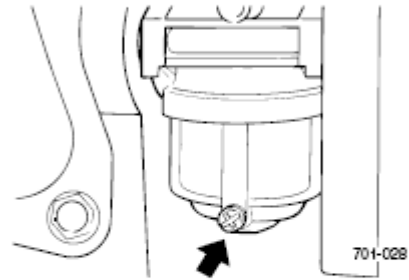

TROUBLESHOOTING

ENGINE WON'T START

1. Check fuel
2. Check engine oil.
3. Engine switch to "ON" "🔌".
4. Check spark plug.
5. If engine still won't start, check following:
 Fuel cock clogging.
 Air Filter clogging.
 Or consult LAPALNTE company.

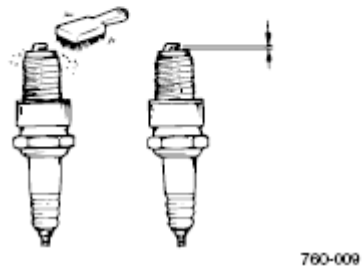
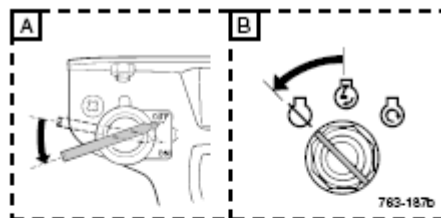
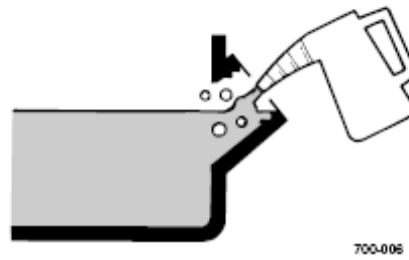
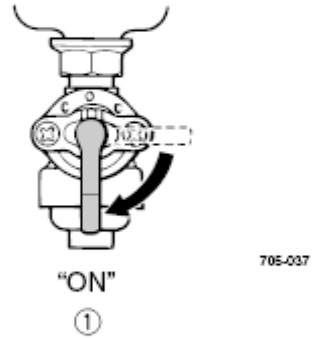
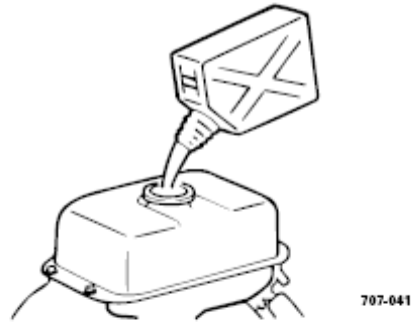

Combination Valve

Piloted discharge check valves combine a pilot valve, a discharge valve, and a check valve into one system used to run an air compressor at a constant speed. They are used on both gas engine and electric motor compressors.



Pilot valve

The pilot valve actuates the head unloader mechanism to provide a means of stopping or starting the compression of air by the compressor without stopping or starting the electric motor.

Identifying The Problem

If your pilot valve is malfunctioning, read the following symptoms and solutions before attempting to adjust the valve. If you simply want to change the setting of your pilot valve, go directly to the adjustment procedure

Symptom 1) The pilot valve loads/unloads in a rapid fashion creating a chattering sound or it will not maintain an unload setting.

One of the following may be true:

1. Excessive vibration can cause the valve to load/unload improperly. To check, put on a glove or other hand protection and grip the pilot valve tightly while cycling the compressor. If the compressor loads and unloads correctly during operation, vibration is causing the problem. To correct this, raise the load pressure 1 PSI and the unload setting 3 PSI using the techniques shown in steps 8 and 9 of the pilot adjustment section.
2. The pilot valve's filter could be plugged or clogged. To check the filter's condition, remove the pilot valve from the tank or line. Remove the nut from the bottom of the valve completely. Pull out the two screens and the filter pad. If the filter is blocked, you need to get a felt replacement. After cleaning the filter area, replace the screen, the filter pad and then the other screen. Complete by screwing the nut back on the body of the pilot valve. (See Diagram Below)

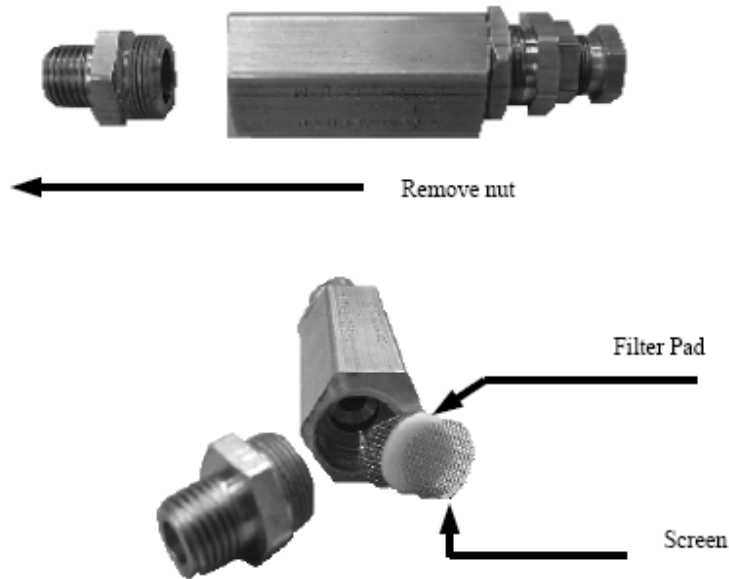

Symptom 2) the pilot valve unloads the compressor correctly but loads it far below the proper setting. Check the following:

1. You may have a leak in the intake unloader line. To test for a leaky unloader line, spray soapy water on the line while the compressor is unloading and look for bubbles. If there are bubbles, the line needs to be patched or replaced. If there are no bubbles, move on to step B.

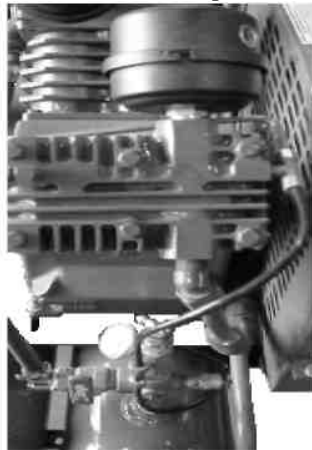

Unloader line to spray

2. may have a leak in the intake unloader or discharge unloader. Perform proper maintenance testing of the unloader to make sure it does not have a leak.
3. may have a leaky pilot valve.

When the compressor is unloading, listen and feel for any excessive air being released at the top of the valve or the stem. If it is leaking, drain all air from the compressor. Unscrew both locknuts and remove the adjustment from the pilot's body. Then remove the stem and the steel ball. Finally, clean the pilot seat with a cotton swab and gasoline or other cleaning fluid. Look for chips or damage to the interior seat. If the seat is chipped, contact LAPLANTE for further instructions. If everything appears correct, place the ball, stem, spring and adjustment into the body. Then, follow the pilot adjustment procedures in adjustment section

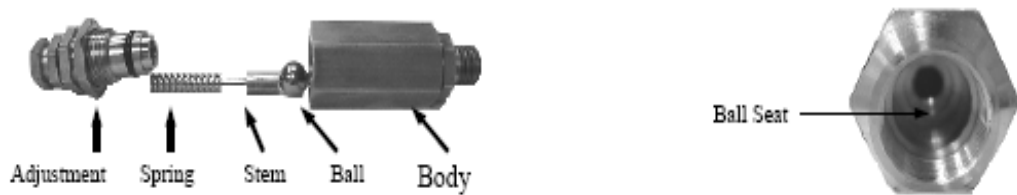

Symptom 3) The pilot valve is not unloading at all and the safety valve is constantly blowing.

Check the following:

1. The inlet may be completely blocked restricting air from reaching the pilot valve. As in the previous section, it is necessary to check the screen and filter of the valve. Follow the instructions for symptom 1 part C. If the unit is not tank mounted, the inlet line may be crimped enough to stop air flow completely. Check the line.
2. The valve differential adjustment screw maybe locking the steel ball down on the body seat. To adjust, refer to the pilot adjustment procedures section
3. The safety valve may be set below the unload setting of the pilot valve causing it to blow before the compressor has a chance to unload. Cycle the compressor normally and make sure it is reaching the unload setting of the unit. If the safety valve is blowing before the unload setting of the compressor, the safety valve is faulty and must be replaced.

CONRADER PILOT VALVE ADJUSTMENT PROCEDURE**TOOLS REQUIRED FOR ADJUSTMENT.**

IF YOU HAVE AN RCB OF ANY TYPE YOU WILL NEED THE FOLLOWING OPEN END WRENCHES:
9/16", 5/8", 3/4"

1. Identify the components of the pilot valve adjustment labeled below. The same terms will be used throughout the instructions. Two important terms must be defined. The **unload setting** is the maximum pressure the pilot valve allows the receiver to reach before unloading the unit. The **load setting** is the minimum pressure the pilot valve allows the receiver to reach before loading the unit.

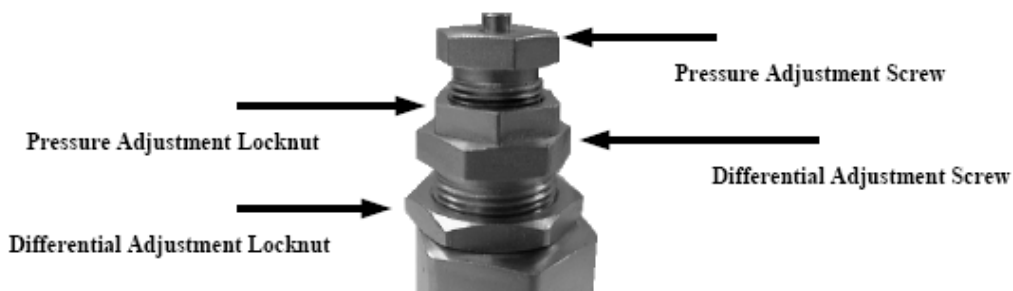

2. Drain all the air from the system and make sure that the safety device is intact. **Note:** Maximum unload setting of the pilot valve should not exceed 90% of the safety device setting. Loosen both the differential and pressure adjustment locknuts completely. Then, gently turn the differential screw **clockwise** until it stops. **WARNING:** DO NOT OVER TIGHTEN THE DIFFERENTIAL SCREW OR THE SEAT OF THE VALVE COULD BE DAMAGED.



3. Remove the pressure adjustment screw from the body of the valve.



4. Reinstall the pressure adjustment screw by turning it two full turns.



5. Restart the compressor. Increase the pressure until the desired load pressure has been reached. Turn off the compressor.

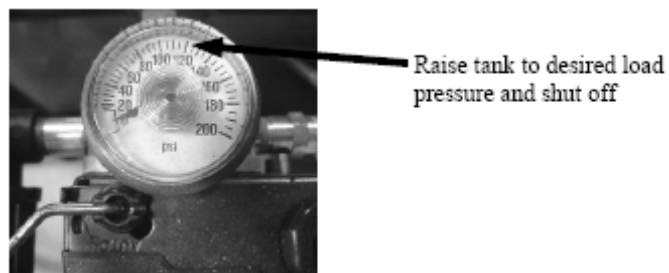

6. Back off the differential screw 1/3 of a turn in the **counterclockwise** direction. Tighten the differential locknut. Backing off the differential screw allows the valve to actuate unloading devices as it would in normal operation.

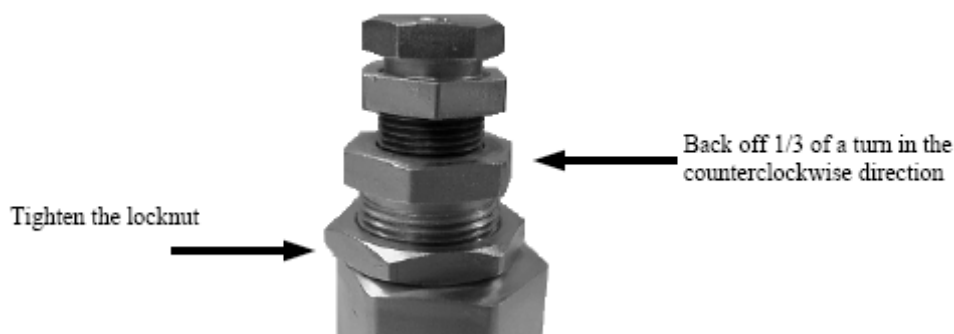

7. While the unit is at the desired load pressure, slowly turn the pressure adjustment screw in the clockwise direction. As you are turning the valve, listen for the valve to load. It will exhaust air from the top of the valve body and make a hissing noise. Once this happens, tighten the pressure adjustment locknut.

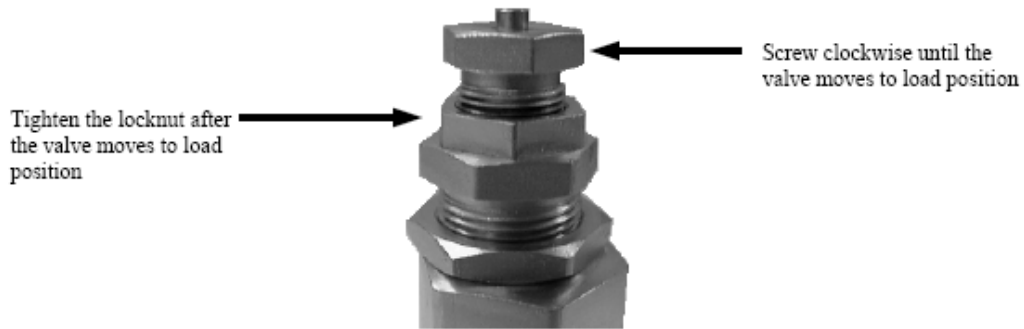

Check valve

The check valve closes when the compressor stops operating, preventing air from flowing out of the tank through the pressure release valve. After the compressor stop operating, if air continues to escape through the release valve, it is an indication that the check valve is leaking. This can be corrected by removing check valve and cleaning disc and seat. If check valve is worn badly, replace same.

Safety information



Before removing check valve be sure all air is drained out of tank and power is disconnected. Failure to do so may result in injury or equipment damage.

Air Receiver

General

Install the compressed air receiver such that nobody is endangered. Protect it from mechanical influences in as much that damage entailing dangerous consequences for persons is not be expected. Ensure that it is possible to operate the compressed air receiver and its equipment from a safe workplace.



Maintain the protection areas and protection space!

Safety information

Ensure that the compressed air receiver is securely mounted and cannot be displaced and tilted by external forces. This also includes the additional weight of the test medium during pressure testing! Where possible, ensure that the receiver is accessible from all sides for repetitive tests. Ensure that the company plate is easily visible.

It is forbidden to undertake repair and modification work which may influence the safety of the compressed air receiver. This applies in particular to work which may change the material properties. Do not undertake welding work on a receiver once the water pressure tests have been passed! Reinforcing plates for mounting plates and brackets are not considered as pressure bearing elements.



Suitable protect compressed air receiver against corrosion.

Adhere to the generally accepted rules of technology when maintaining and installing the receiver.

Checking the safety valve



The safety valve must respond when the compressor pressure increases too high.

The inter stage pressure relief valve is provided to protect against inter stage over pressure and is factory set for maximum pressure of 175 PSIG. If the pressure relief valve pops open, it indicates trouble. Shut down the unit immediately and determine and correct the malfunction. Inspect the head valves. Serious damage can result if not corrected and can lead to complete destruction of the unit. Tampering with the inter stage pressure relief valve, or plugging the opening destroys the protection provided and voids all warranty.

The valve must be able to blow off the entire delivery quantity of the compressor. As it is rarely or never operated, it is of utmost importance for the safety of the compressor that the valve is regularly checked. Check the valve once a year or after 2000 operating hours.

This is the only maintenance work which has to be performed while the compressor is running. Make sure that all safety devices are correctly installed! Never perform this work with the safety device removed!



Danger of injury or death!



Do not readjust!!

Test safety valve on tank:

A ring is located at the free end of the safety valve. Pull the ring by hand. Never remove the lead seal at the head of the valve!

If you now pull the ring further, the safety valve should blow off increasingly more air.

If the valve blows off correctly, drop hand tight in its seating and complete the check.

- If the valve does not blow off although you have pull the ring up to the end of the stud, it is defective. Please have a new safety valve fitted by **LAPLANTE** Service.

Condensate

Manually draining off condensate from the compressed air receiver

If no automatic condensate separator is fitted, drain off the condensate by hand at least once a week.



Depressurize the receiver.

Place a suitable collecting basin underneath the ball valve under the receiver.

Open the ball valve and allow the condensate to drain off into the collecting basin.

Once the condensate has completely drained off, close the ball valve again and correctly dispose of the condensate.

Safety information



Please observe the following instructions when performing any maintenance, cleaning, repair work; when relocating the compressor plant; prior to installing and dismantling component parts, receivers, fittings and screw connections.

- **Always isolate the compressor at the main switch prior to performing any maintenance work.**
Secure the main switch against accidental switching on! Remove the electrical fuses in order to avoid accidents!
- **Depressurize the compressor!**
Disconnect from the compressed air network by closing the ball valve on the compressed air outlet.
- **Perform maintenance or servicing work.**
- **Only allow skilled and qualified welders to perform welding work on compressed air receivers!**
After welding work on compressed air receivers, new constructional and hydrostatic pressure tests are to be carried out.
- **Prior to switching on again, check whether anyone else is working on the compressor!**

For your own safety, never omit a safety step!

Otherwise you will risk injury from restarting, electric shock or parts which may fly off!

Check V-belts for damage and replace with new ones, if necessary

The belts should be checked for damage and wear after every 2000 hours or once yearly.

- Remove the belt guard
- Turn the belts slowly using the fan wheel.
- Check - in addition to foreign bodies- for large eruptions in the flanks of the belts and for tears in the fabric indicating the belt is becoming brittle.

If it is necessary to change the belts, proceed as follows:

- Unscrew the four retaining screws with a suitable spanner from the slots in the motor plate.
- Completely slacken the V-belts. Turn the tensioning block using the spanner.
- Remove the belts from the pulleys and clean, if necessary.
- Check the flanks of the pulleys and clean, if necessary.
- Fit new V-belts. Only change the belts as a complete set, never individually!
- Retension the V-belts: Turn the tensioning spindle clockwise until achieving the correct belt tension, i.e. when a testing force of 30 N applied vertically to the belt between drive and flywheel causes the belts to sag by approx. 10 - 12 mm.
- After setting the correct belt tension, screw the motor plate firmly in place and replace the belt guard.